

COTEK



SC Series User's Manual

SC-1200 / SC-2000

PURE SINE WAVE INVERTER CHARGER

Table of Content

1. SAFETY INSTRUCTIONS	1
1-1. Warnings and symbols	1
1-2. Use for intended purpose general safety precautions	1
1-3. Other safety notes and installation precautions	1
1-4. Warning regarding the use of batteries	2
2. FUNCTION CHARACTERISTICS INTRODUCTION	3
2-1. System overview	3
2-2. Electrical specification	4
2-3. Mechanical drawings	8
3. INSTALLATION AND MAINTENANCE	9
3-1. Unpacking the product	9
3-2. Front panel	9
3-3. Rear panel	14
3-4. Mounting Instruction	18
4. SYSTEM FUNCTION INTRODUCTION	19
4-1. Battery charger introduction	19
4-2. Operation mode introduction	22
5. TROUBLE SHOOTING	25
6. IMPORTANT SAFETY INSTRUCTIONS	25
7. WARRANTY	27

1. Safety Instructions

1-1. Warnings and symbols

Safety instructions and warnings are marked in this manual by the following pictograms :



Supplementary information on operating the device.



CAUTION

Safety instruction: Failure to observe this instruction can cause material damage and impair the function of the device.



CAUTION

Safety instruction relating to a danger from an electrical current or voltage. Failure to observe this instruction can cause material damage and personal injury and impair the function of the device.



WARNING!

SAVE THESE INSTRUCTIONS – This manual contains important instructions that should be followed during installation and maintenance of the unit.

1-2. Use for intended purpose general safety precautions

The unit is constructed as per the applicable safety-technical guidelines.

- For the charging of lead acid batteries and the supply of user attached to these batteries, in permanent systems.
- For the conversion of a DC voltage from a battery to and AC voltage.
- Do not expose the unit to rain, snow, spray or dust. To reduce the risk of fire hazard, do not cover or obstruct the ventilation openings and. do not install the unit in a zero-clearance compartment.
- To avoid the risk of fire and electric shock, make sure that the existing wiring is in good electrical condition; and that the wire size is not undersized.
Do not operate the unit with damaged or substandard wiring.
- Depending on the use, the AC output of the unit may require user installed breaker or fusing. The unit incorporates standard AC short circuit protection.
- The following precautions should be taken when working on the Inverter Charger :
 - ◆ Remove watches, rings, or other metal objects.
 - ◆ Use tools with insulated handles.
 - ◆ Wear rubber gloves and boots.

1-3. Other safety notes and installation precautions

- Upon receipt, examine the shipment box for damage. Notify the carrier immediately, before opening, if damage is evident.
- Do not operate near water or in excessive humidity.
- Do not open or disassemble the unit, warranty may be voided.

- The DC and AC side connections should be firm and tight.
- Grounding : Reliable grounding of rack-mounted equipment should be maintained.
- Do not drop a metal tool on the battery. The resulting sparks or short-circuit on the battery or on the other electrical part may cause an explosion.
- Wiring : Adequate input power must be supplied to the unit for proper use; correct wiring sizes must be ensured.
- Do not operate the unit close to combustible gas or open fire.
- Temperature : The unit should be operated in an ambient temperature range of -20 to 40°C or else the output efficiency may be affected. Air flow to the unit must not be restricted.
- In case of fire, you must use the fire extinguisher which is appropriate for electrical equipment.
- Short circuiting or reversing polarity will lead to serious damage to batteries, unit and the wiring. Fuses between the batteries and the unit cannot prevent damage caused by reversed polarity and the warranty will be void.
- Do not work on unit or system if it is still connected to a power source. Only allow changes in your electrical system to be carried out by qualified electricians.
- Check the wiring and connections at least once a year. Defects such as loose connections, burned cables etc. must be corrected immediately.
- Do not touch the equipment when wet or if your hands are clammy.

**CAUTION**

The cabinet of the unit must not be opened. There are no serviceable parts inside the cabinet. Only qualified, authorized and trained electrician installers are authorized to open the connection compartment.

1-4. Warning regarding the use of batteries

Excessive battery discharge and / or high charging voltage can cause serious damage to batteries. Do not exceed the recommended limits of discharge level of your batteries. Avoid short circuiting batteries, as this may result in explosion and fire hazard. Installation of the batteries and adjustments of the unit should only be undertaken by authorized personnel!

2. Function Characteristics Introduction

2-1. System overview

The SC Series is an inverter / charger system, designed with advanced power electronic and digital signal processor technology offering the following features :

- Bi-directional All-in-One Design.
- Certified by UL (UL458 & Supplement SA / UL1741).
- Compact Size - Highly Integration = Installation hassle-free.
- 5-in-1 Operating Modes
- Battery charger current as below table.

Model No.	MAX	Battery voltage
SC1200-124 SC1200-224	25A	24V
SC1200-112 SC1200-212 SC2000-124 SC2000-224	50A	12V@SC1200 24V@SC2000
SC2000-112 SC2000-212	100A	12V

Table 1 : SC series battery charger current

- Equalization charging function for the batteries.

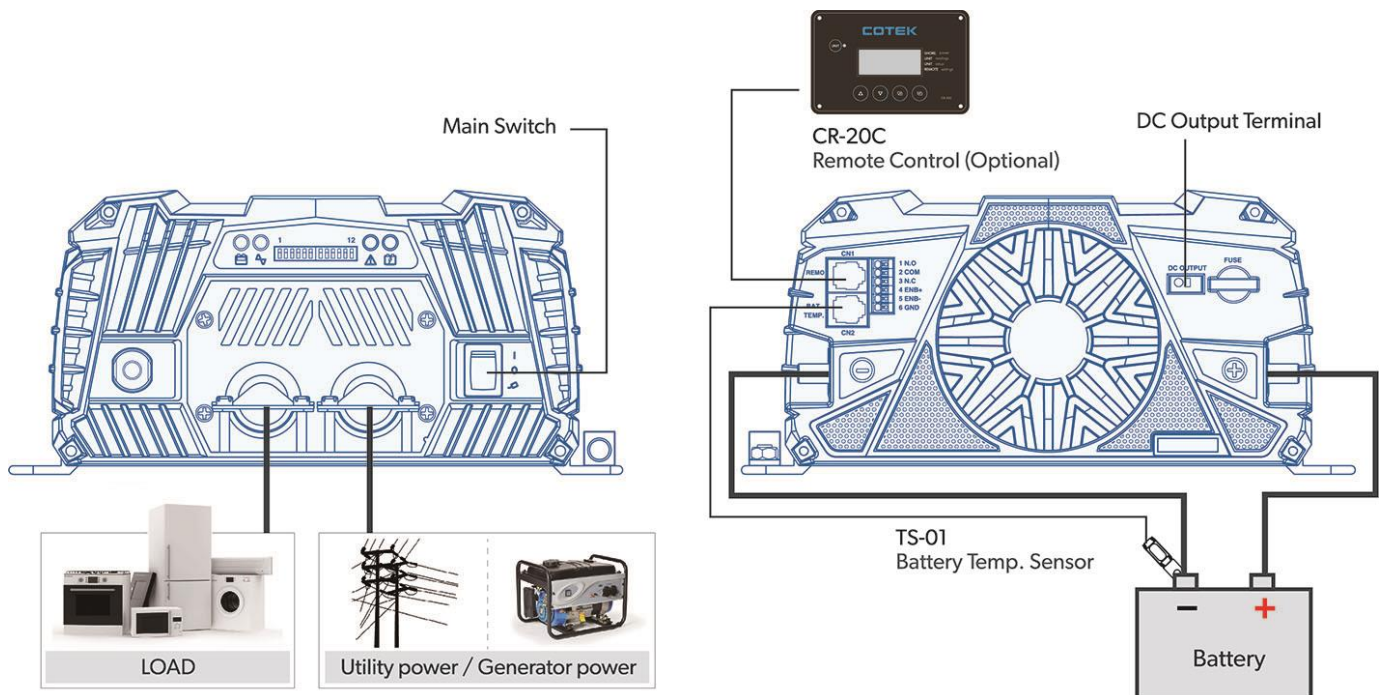

Fig. 1 : SC series System Overview

2-2. Electrical specification

Electrical		Specification	Model No.				
		Item	SC-1200-112	SC-1200-124	SC-1200-212	SC-1200-224	
Inverter Mode	Input Characteristics	Nominal Voltage	12 VDC	24 VDC	12 VDC	24 VDC	
		Input Voltage Range ($\pm 0.5V$)	10.5 ~ 16.5 VDC	21 ~ 33 VDC	10.5 ~ 16.5 VDC	21 ~ 33 VDC	
		Input Over-Voltage Protection ($\pm 0.5V$)	16.5 VDC	33 VDC	16.5 VDC	33 VDC	
		Input Over-Voltage Warning ($\pm 0.5V$)	15.5 VDC	31 VDC	15.5 VDC	31 VDC	
		Input Under-Voltage Protection ($\pm 0.5V$)	10.5 VDC	21 VDC	10.5 VDC	21 VDC	
		Input Under-Voltage Warning ($\pm 0.5V$)	11.0 VDC	22.0 VDC	11.0 VDC	22.0 VDC	
		Input Current (Max)	132 A	66 A	132 A	66 A	
		No Load Current	< 3.0 A @12.5V	< 1.5 A @25V	< 3.0 A @12.5V	< 1.5 A @25V	
		Stand-By Current	< 0.4 A	< 0.2 A	< 0.4 A	< 0.2 A	
	Output Characteristics	Continuous Output Power	1200 VA \pm 3%				
		Surge Power	Load 101%~115% (1 Min)				
			2400 VA (2 Sec)				
		Frequency	50/60 Hz \pm 0.3 Hz (User-selectable)				
		Output Voltage	100 / 110 / 115 / 120VAC \pm 3%		200 / 220 / 230 / 240VAC \pm 3%		
		Max. Efficiency (Full Load)	89%	90%	89%	90%	
		Output Waveform	Pure Sine Wave (THD < 5% @ 12.5V/25V/115VAC, linear load) / (THD < 3% @ 12.5V/25V/230VAC, linear load)				
		INV. AC Output*	12A MAX		6A MAX		
	AC Output*	30A MAX		22A MAX			
	Protection	Input Protection	Over / Under Voltage, Reverse Polarity (Internal Fuse)				
		AC Output Protection	Short-Circuit, Overload				
		AC Input Protection	30 Amp Circuit Breaker		16 Amp Circuit Breaker		
		Temperature protection	Shutdown				
		Battery Temperature protection	By a RJ-11 connector to battery Temperature sensor				
	Charger Mode	AC input Characteristics	Nominal Voltage / Frequency	110 VAC, 50 / 60Hz (User-selectable)		230 VAC, 50 / 60Hz (User-selectable)	
			Input Voltage Range	90 ~ 132 VAC		180 ~ 264 VAC	
			Input Frequency Range	50Hz:47 ~ 53 Hz / 60Hz:57 ~ 63 Hz			
			Nominal Current	8.2A (@110VAC)		3.9A (@230VAC)	
			Efficiency (Max.)	>88%			

Electrical		Specification	Model No.			
		Item	SC-1200-112	SC-1200-124	SC-1200-212	SC-1200-224
		AC Input*	30 A MAX		16 A MAX	
		Power Factor Correction(PFC)	>0.95 (Max.)			
	Auxiliary DC Output	Output Voltage	Battery Voltage			
		Output Current	20A Max			
	DC Output Characteristics	Charging Current Range	12.5 / 25 / 37.5 / 50A	6.25 / 12.5 / 18.75 / 25A	12.5 / 25 / 37.5 / 50A	6.25 / 12.5 / 18.75 / 25A
		Max. Output Voltage	14.4 VDC @ GEL TYPE	28.8 VDC @ GEL TYPE	14.4 VDC @ GEL TYPE	28.8 VDC @ GEL TYPE
		Battery Temperature Compensation	-25 mV per °C	-50 mV per °C	-25 mV per °C	-50 mV per °C
		Battery Control (3-stage Battery Chargers)	Bulk / Absorption / Float			
	Signal and Control	Remote Control Panel (Optional)	CR-20C / CR-16B / CR-8			
		Remote Control Terminal	Controls the inverter ON / OFF operation			
		Dry Contact Terminal	By a relay			
	Bypass Relay	Relay Specification	30 Amp / 120 VAC @ 110V system		16 Amp / 250 VAC @ 230V system	
	Operating Temperature Range	Full Load	-20 °C ~ 50 °C*			
		Power de-rating	40 W / °C, 51~60 °C			
Storage		-30 °C ~70 °C				
Operating Humidity Range	Max 93%, Non-condensing					
Cooling	Temperature & Load Controlled Cooling Fan					
Power Sharing Function	Inverter mode / Charger mode / Power sharing Power Generator / Power support					
Mechanical Specification	Dimension (W x H x D)	251 x 116 x 386mm				
	Net Weight	4.55Kg				
Safety and EMS	Safety Standards	UL458 & Supplement SA / UL1741		EN 62368-1		
	E-mark	---		Certified CISPR 25; ISO7637-2		
	EMC Standards	Certified FCC Class A*		EN55032 Class A*, EN55024 Class A* EN61000-3-2, 3-3 EN61000-4-2, 3, 4, 5, 6, 8, 11		

Table 2. SC-Series Specification.

Note :

1. Max Inverter output define inverter 100% load output at Vac =100V / 200V
2. Max AC output define AC input current + Inverter output current, cannot over AC input limit.
3. Max AC input current Limit by the Breaker
4. SC series is a class A product. In a domestic environment this product may cause radio interference in which case the user may be required to take adequate measures.
5. For SC-1200 -112 and -124, the operating temperature range certified by UL Safety Standard is -20°C ~ 40°C.

Electrical		Specification	Model No.				
		Item	SC-2000-112	SC-2000-124	SC-2000-212	SC-2000-224	
Inverter Mode	Input Characteristics	Nominal Voltage	12 VDC	24 VDC	12 VDC	24 VDC	
		Input Voltage Range ($\pm 0.5V$)	10.5 ~ 16.5 VDC	21 ~ 33 VDC	10.5 ~ 16.5 VDC	21 ~ 33 VDC	
		Input Over-Voltage Protection ($\pm 0.5V$)	16.5 VDC	33 VDC	16.5 VDC	33 VDC	
		Input Over-Voltage Warning ($\pm 0.5V$)	15.5 VDC	31 VDC	15.5 VDC	31 VDC	
		Input Under-Voltage Protection ($\pm 0.5V$)	10.5 VDC	21 VDC	10.5 VDC	21 VDC	
		Input Under-Voltage Warning ($\pm 0.5V$)	11.0 VDC	22.0 VDC	11.0 VDC	22.0 VDC	
		Input Current (Max)	260 A	130 A	260 A	130 A	
		No Load Current	< 4.0 A @12.5V	< 2.0 A @25V	< 4.0 A @12.5V	< 2.0 A @25V	
		Stand-By Current	< 0.4 A	< 0.2 A	< 0.4 A	< 0.2 A	
	Output Characteristics	Continuous Output Power	2000 VA \pm 3%				
		Surge Power	Load 101%~115% (1 Min)				
			4000 VA (2 Sec)				
		Frequency	50/60 Hz \pm 0.3 Hz (User-selectable)				
		Output Voltage	100 / 110 / 115 / 120VAC \pm 3%		200 / 220 / 230 / 240VAC \pm 3%		
		Max. Efficiency (Full Load)	89%	90%	89%	90%	
		Output Waveform	Pure Sine Wave (THD < 5% @ 12.5V/25V/115VAC, linear load) / (THD < 3% @ 12.5V/25V/230VAC, linear load)				
		INV. AC Output*	20A MAX		10A MAX		
	AC Output*	30A MAX		26A MAX			
	Protection	Input Protection	Over / Under Voltage, Reverse Polarity (Internal Fuse)				
		AC Output Protection	Short-Circuit, Overload				
		AC Input Protection	30 Amp Circuit Breaker		16 Amp Circuit Breaker		
		Temperature protection	Shutdown				
		Battery Temperature protection	By a RJ-11 connector to battery Temperature sensor				
	Charger Mode	AC input Characteristics	Nominal Voltage / Frequency	110 VAC, 50 / 60Hz (User-selectable)		230 VAC, 50 / 60Hz (User-selectable)	
			Input Voltage Range	90 ~ 132 VAC		180 ~ 264 VAC	
			Input Frequency Range	50Hz:47 ~ 53 Hz / 60Hz:57 ~ 63 Hz			
			Nominal Current	16.5A (@110VAC)		7.9A (@230VAC)	
Efficiency (Max.)			>88%				
AC Input*			30 A MAX		16 A MAX		
Power Factor Correction(PFC)			>0.95 (Max.)				

Electrical		Specification	Model No.			
		Item	SC-2000-112	SC-2000-124	SC-2000-212	SC-2000-224
	Auxiliary DC Output	Output Voltage	Battery Voltage			
		Output Current	20A Max			
	DC Output Characteristics	Charging Current Range	25 / 50 / 75 / 100A	12.5 / 25 / 37.5 / 50A	25 / 50 / 75 / 100A	12.5 / 25 / 37.5 / 50A
		Max. Output Voltage	14.4 VDC @ GEL TYPE	28.8 VDC @ GEL TYPE	14.4 VDC @ GEL TYPE	28.8 VDC @ GEL TYPE
		Battery Temperature Compensation	-25 mV per °C	-50 mV per °C	-25 mV per °C	-50 mV per °C
		Battery Control (3-stage Battery Chargers)	Bulk / Absorption / Float			
	Signal and Control	Remote Control Panel (Optional)	CR-20C / CR-16B / CR-8			
		Remote Control Terminal	Controls the inverter ON / OFF operation			
		Dry Contact Terminal	By a relay			
	Bypass Relay	Relay Specification	30 Amp / 120 VAC @ 110V system		16 Amp / 250 VAC @ 230V system	
Operating Temperature Range	Full Load	-20 °C ~ 40 °C				
	Power de-rating	60 W / °C, 41~60 °C				
	Storage	-30 °C ~70 °C				
Operating Humidity Range	Max 93%, Non-condensing					
Cooling	Temperature & Load Controlled Cooling Fan					
Power Sharing Function	Inverter mode / Charger mode / Power sharing Power Generator / Power support					
Mechanical Specification	Dimension (W x H x D)	251 x 116 x 453mm				
	Net Weight	6 Kg				
Safety and EMS	Safety Standards	UL458 & Supplement SA / UL1741		EN 62368-1		
	E-mark	---		Certified CISPR 25; ISO7637-2		
	EMC Standards	Certified FCC Class A*		EN55032 Class A*, EN55024 Class A*, EN61000-3-2, 3-3 EN61000-4-2, 3, 4, 5, 6, 8, 11		

Table 3. SC-Series Specification

Note :

1. Max Inverter output define inverter 100% load output at Vac =100V / 200V
2. Max AC output define AC input current + Inverter output current, cannot over AC input limit.
3. Max AC input current Limit by the Breaker
4. SC series is a class A product. In a domestic environment this product may cause radio interference in which case the user may be required to take adequate measures.

De-rating Curve

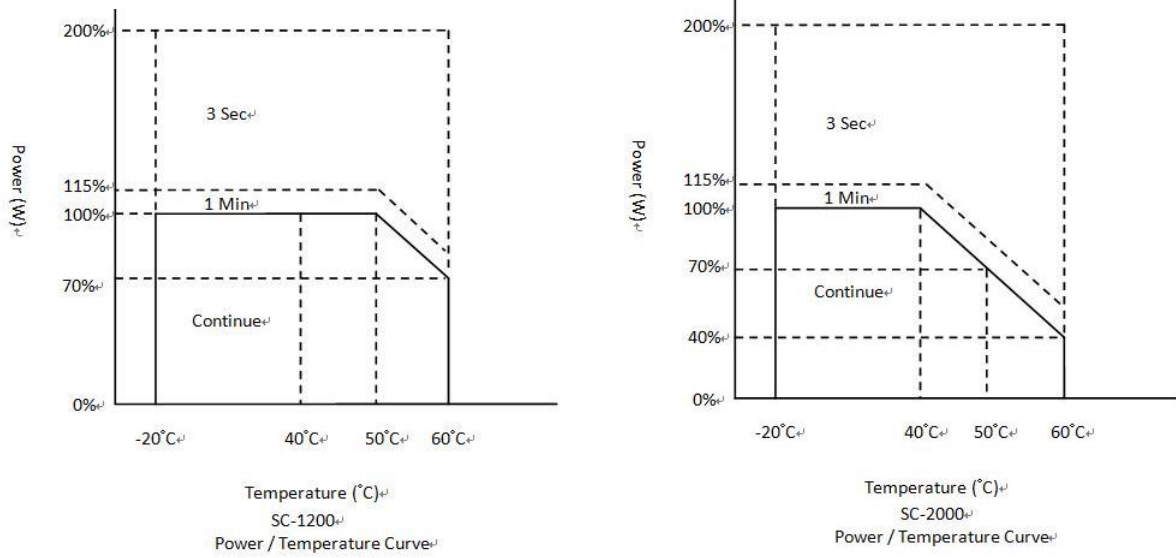

Fig. 2 : SC series De-rating Curve

2-3. Mechanical drawings Unit : mm[inch]

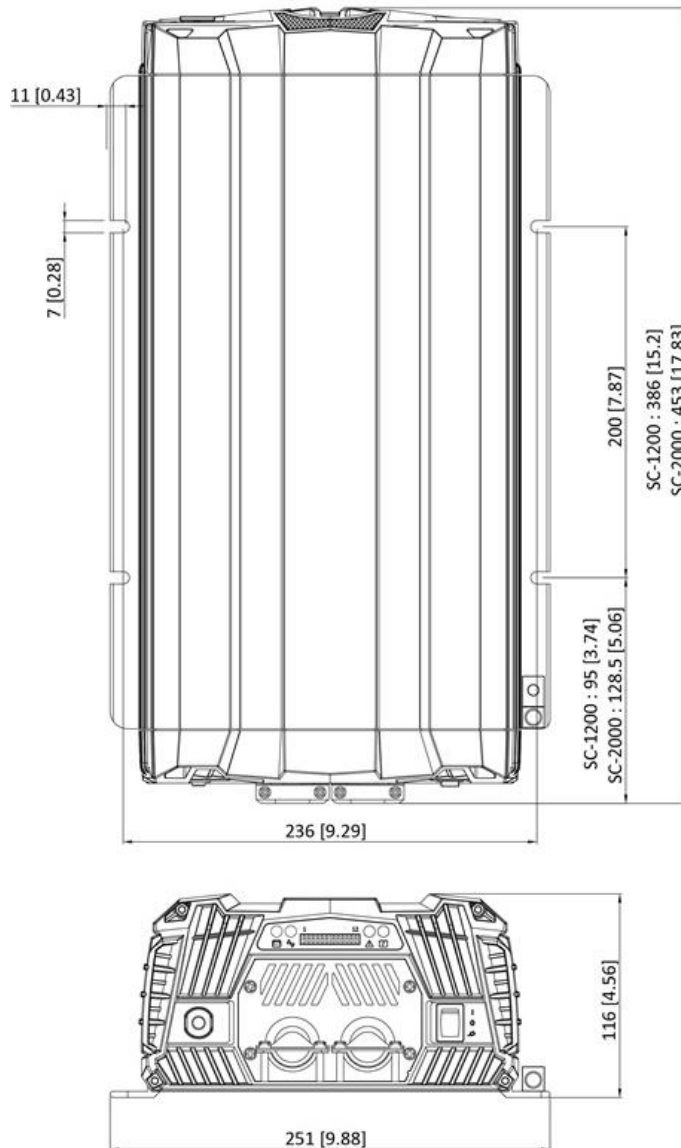

Fig. 3 : SC series Mechanical drawings

3. Installation and Maintenance

During installation and commissioning of the unit, the Safety Guidelines & Measures are applicable at all times. See chapter 1 of this manual.

3-1. Unpacking the product

In addition to the unit the delivery includes :

- Battery temperature sensor TS-01 (optional)
- Remote Control CR-20C (optional or combo pack only)
- Quick Instruction Guide

After unpacking, check the contents for possible damage. Do not use the product if it is damaged. In case of the contents damaged, please contact your supplier.

Check from the identification label whether the battery voltage is the same as the DC-input voltage of the unit (e.g. 12V battery set for a 12V input voltage). Also check that the AC output voltage and output power of the unit satisfies loading requirements.

3-2. Front Panel

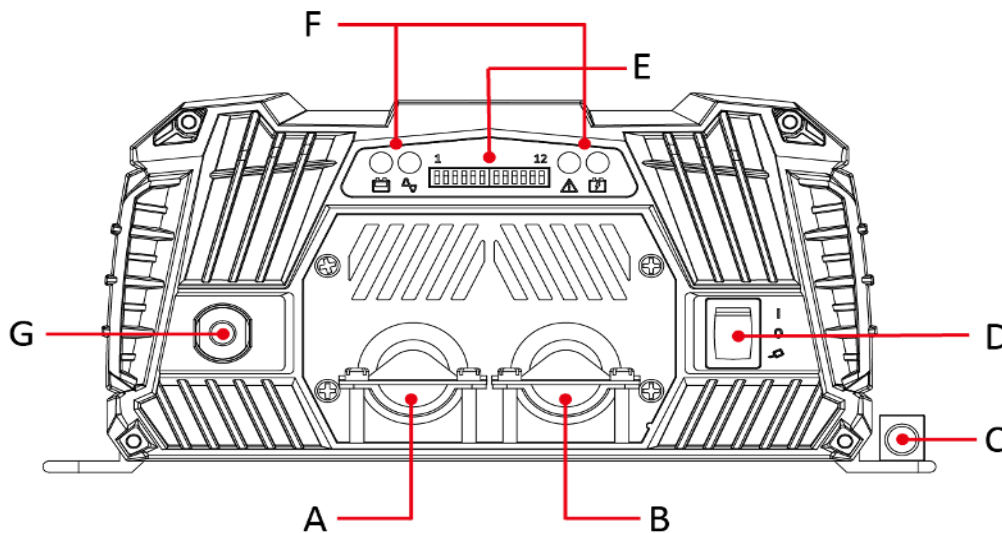



Fig. 4 : SC series front panel introduction

Front panel									
A	<p>AC Output</p> <p>Two 3/4 inch knockouts provided with cable-clamp strain reliefs to allow and hold the AC input and output field wiring.</p>								
B	<p>AC Input</p> <table border="1" style="width: 100%;"> <thead> <tr> <th colspan="2">Front panel</th> </tr> </thead> <tbody> <tr> <td style="text-align: center;">1</td> <td>AC Output terminal (L/N)</td> </tr> <tr> <td style="text-align: center;">2</td> <td>AC Input terminal (L/N)</td> </tr> <tr> <td style="text-align: center;">3</td> <td>AC Input / Output ground terminal</td> </tr> </tbody> </table>	Front panel		1	AC Output terminal (L/N)	2	AC Input terminal (L/N)	3	AC Input / Output ground terminal
Front panel									
1	AC Output terminal (L/N)								
2	AC Input terminal (L/N)								
3	AC Input / Output ground terminal								

		<table border="1"> <thead> <tr> <th>Model No.</th> <th>AC IN AWG</th> <th>AC OUT AWG</th> <th>GROUNDING AWG</th> </tr> </thead> <tbody> <tr> <td>SC1200-112</td> <td>30A/10AWG</td> <td>30A/10AWG</td> <td>30A/10AWG</td> </tr> <tr> <td>SC1200-124</td> <td>30A/10AWG</td> <td>30A/10AWG</td> <td>30A/10AWG</td> </tr> <tr> <td>SC1200-212</td> <td>16A/12AWG</td> <td>22A/10AWG</td> <td>22A/10AWG</td> </tr> <tr> <td>SC1200-224</td> <td>16A/12AWG</td> <td>22A/10AWG</td> <td>22A/10AWG</td> </tr> <tr> <td>SC2000-112</td> <td>30A/10AWG</td> <td>30A/10AWG</td> <td>30A/10AWG</td> </tr> <tr> <td>SC2000-124</td> <td>30A/10AWG</td> <td>30A/10AWG</td> <td>30A/10AWG</td> </tr> <tr> <td>SC2000-212</td> <td>16A/12AWG</td> <td>26A/10AWG</td> <td>26A/10AWG</td> </tr> <tr> <td>SC2000-224</td> <td>16A/12AWG</td> <td>26A/10AWG</td> <td>26A/10AWG</td> </tr> </tbody> </table>	Model No.	AC IN AWG	AC OUT AWG	GROUNDING AWG	SC1200-112	30A/10AWG	30A/10AWG	30A/10AWG	SC1200-124	30A/10AWG	30A/10AWG	30A/10AWG	SC1200-212	16A/12AWG	22A/10AWG	22A/10AWG	SC1200-224	16A/12AWG	22A/10AWG	22A/10AWG	SC2000-112	30A/10AWG	30A/10AWG	30A/10AWG	SC2000-124	30A/10AWG	30A/10AWG	30A/10AWG	SC2000-212	16A/12AWG	26A/10AWG	26A/10AWG	SC2000-224	16A/12AWG	26A/10AWG	26A/10AWG
Model No.	AC IN AWG	AC OUT AWG	GROUNDING AWG																																			
SC1200-112	30A/10AWG	30A/10AWG	30A/10AWG																																			
SC1200-124	30A/10AWG	30A/10AWG	30A/10AWG																																			
SC1200-212	16A/12AWG	22A/10AWG	22A/10AWG																																			
SC1200-224	16A/12AWG	22A/10AWG	22A/10AWG																																			
SC2000-112	30A/10AWG	30A/10AWG	30A/10AWG																																			
SC2000-124	30A/10AWG	30A/10AWG	30A/10AWG																																			
SC2000-212	16A/12AWG	26A/10AWG	26A/10AWG																																			
SC2000-224	16A/12AWG	26A/10AWG	26A/10AWG																																			
C	Chassis ground	<p>This connection is used to tie the exposed chassis of the inverter to the DC grounding system. This terminal accepts CU/AL conductors from #14 to #2 AWG (2.1 to 33.6 mm²).</p> <div style="display: flex; align-items: center;">  <p>WARNING! The ground wire offers protection only if the cabinet of the unit is connected to the safety ground. Connect the chassis ground. Terminal to the hull or the chassis.</p> </div> <p>Refer to local regulations on these issues!</p> <p>For safety purposes the neutral conductor (N) of the AC output must be connected to the earth (PE / GND) when the unit is in inverter operation. When utility power is available on the AC input, and the unit is in charger mode, this connection must be disabled again. In some applications automatic connection between the neutral conductor (N) and earth (PE / GND) is not required or acceptable. Therefore the automatic connection between the neutral conductor (N) and earth (PE / GND) is enabled by default.</p>																																				
D	Main switch	The switch for 1.Power ON 2.Power Off 3.Remote Mode.																																				
E	DIP switch	<div style="text-align: center;">  </div> <table border="1" style="width: 100%; border-collapse: collapse;"> <thead> <tr style="background-color: #4a5568; color: white;"> <th>Dip Switch</th> <th>Function</th> </tr> </thead> <tbody> <tr> <td>S1</td> <td rowspan="2">Output Voltage Select (refer to 3-2-1-1)</td> </tr> <tr> <td>S2</td> </tr> <tr> <td>S3</td> <td>Frequency Select (refer to 3-2-1-2)</td> </tr> <tr> <td>S4</td> <td rowspan="3">AC Input Current Limit Select (refer to 3-2-1-3)</td> </tr> <tr> <td>S5</td> </tr> <tr> <td>S6</td> </tr> <tr> <td>S7</td> <td rowspan="2">Battery Type Select (refer to 3-2-1-4)</td> </tr> <tr> <td>S8</td> </tr> <tr> <td>S9</td> <td rowspan="2">Charger Current Select (refer to 3-2-1-5)</td> </tr> <tr> <td>S10</td> </tr> <tr> <td>S11</td> <td>DC Source on/off (refer to 3-2-1-6)</td> </tr> <tr> <td>S12</td> <td>Saving Function on/off (refer to 3-2-1-7)</td> </tr> </tbody> </table>	Dip Switch	Function	S1	Output Voltage Select (refer to 3-2-1-1)	S2	S3	Frequency Select (refer to 3-2-1-2)	S4	AC Input Current Limit Select (refer to 3-2-1-3)	S5	S6	S7	Battery Type Select (refer to 3-2-1-4)	S8	S9	Charger Current Select (refer to 3-2-1-5)	S10	S11	DC Source on/off (refer to 3-2-1-6)	S12	Saving Function on/off (refer to 3-2-1-7)															
Dip Switch	Function																																					
S1	Output Voltage Select (refer to 3-2-1-1)																																					
S2																																						
S3	Frequency Select (refer to 3-2-1-2)																																					
S4	AC Input Current Limit Select (refer to 3-2-1-3)																																					
S5																																						
S6																																						
S7	Battery Type Select (refer to 3-2-1-4)																																					
S8																																						
S9	Charger Current Select (refer to 3-2-1-5)																																					
S10																																						
S11	DC Source on/off (refer to 3-2-1-6)																																					
S12	Saving Function on/off (refer to 3-2-1-7)																																					
F	Function LED	From left to right is "Battery voltage", "AC output load", "Charger stage", "System status" <i>*For details, refer to 3-2-2</i>																																				

G	AC input breaker	
----------	-------------------------	--

Table 4 : SC series front panel introduction

3-2-1. DIP(Function) switch : (reference E)



3-2-1-1 Output Voltage switch Function (S1,S2) :

Output Voltage	S1	S2
100V / 200V	OFF	OFF
110V / 220V	ON	OFF
115V / 230V	OFF	ON
120V / 240V	ON	ON

Table 5 : Output voltage function definition

3-2-1-2 Output Frequency switch Function (S3) :

Frequency	S3
50HZ	OFF
60HZ	ON

Table 6 : Output frequency function definition

3-2-1-3 AC Input Current Limit Select (S4,S5,S6) : Default : 15A/10A

AC Input Current 100~120V / 200~240V	S4	S5	S6
3A / 2A	OFF	OFF	OFF
6A / 4A	ON	OFF	OFF
9A / 6A	OFF	ON	OFF
12A / 8A	ON	ON	OFF
15A / 10A	OFF	OFF	ON
20A / 12A	ON	OFF	ON
25A / 14A	OFF	ON	ON
30A / 16A	ON	ON	ON

Table 7 : SC series Input current limit select function definition

3-2-1-4 Battery Type Select Function(S7,S8) : Default : GEL

Battery Type	S7	S8
GEL	OFF	OFF
Flooded	ON	OFF
AGM	OFF	ON
Customer	ON	ON

Table 8 : Battery types select function definition

3-2-1-5 Charger current Select Function(S9,S10) : Default : 100%

Charger Current (%)	S9	S10
25%	OFF	OFF
50%	ON	OFF
75%	OFF	ON
100%	ON	ON

Table 9 : Charger current select function definition

3-2-1-6 DC Source Output On/Off Function (S11) : Default : OFF

ESB function	S11
OFF	OFF
ON	ON

Table 10 : DC source output On/Off function definition

3-2-1-7 Saving Function Switch On/Off Function (S12) : Default : OFF

The saving mode will be triggered if the output load <20W @10seconds.

Saving function	S12
OFF	OFF
ON	ON

Table 11 : Saving function switch On/Off function definition

3-2-2 Status LED indicator : (reference F)





Icon	Description	Icon	Description
	Battery Input voltage indicator		Output Load indicator
	Alarm indicator		Charger Stage indicator

Table 12 : LED indicator













Status	LED Indicator				
Green	Off				Inverter mode
	 Solid ON	Normal (12V: 11.5 ~ 15.0V) (24V: 23.0 ~ 30.0V)	Normal (0~100%)	Normal status	Float mode
	 Slow Blink			Over Temperature Protection	Equalization mode
	 Fast Blink			Under Temperature Protection	Active mode
Orange	Off				Inverter mode
	 Solid ON	Battery Low voltage (12V:11.0 ~ 11.5V) (24V:22.0 ~ 23.0V) Battery High voltage (12V:15.0 ~ 15.5V) (24V:30.0 ~ 31.0V)	Over load (100%-115%)	Phase or Frequency Failure	Absorption mode
	 Slow Blink			Grid Over / Under Voltage Protection	Bulk mode
	 Fast Blink			Grid Over Current Protect	
Red	Off				Inverter mode
	 Solid ON	Battery Under voltage (12V: < 11.0V) (24V: < 22.0V) Battery Over voltage (12V: >15.5V) (24V: >31.0V)	Over load (>115%)	Over Load / Short Circuit Protection	
	 Slow Blink			Battery Under Voltage Protection (12V: < 10.5V) (24V: < 21.0V)	
	 Fast Blink			Battery Over Voltage Protection (12V: >16.5V) (24V: >33.0V)	

Table 13 : Status LED indicator

3-3. Rear panel

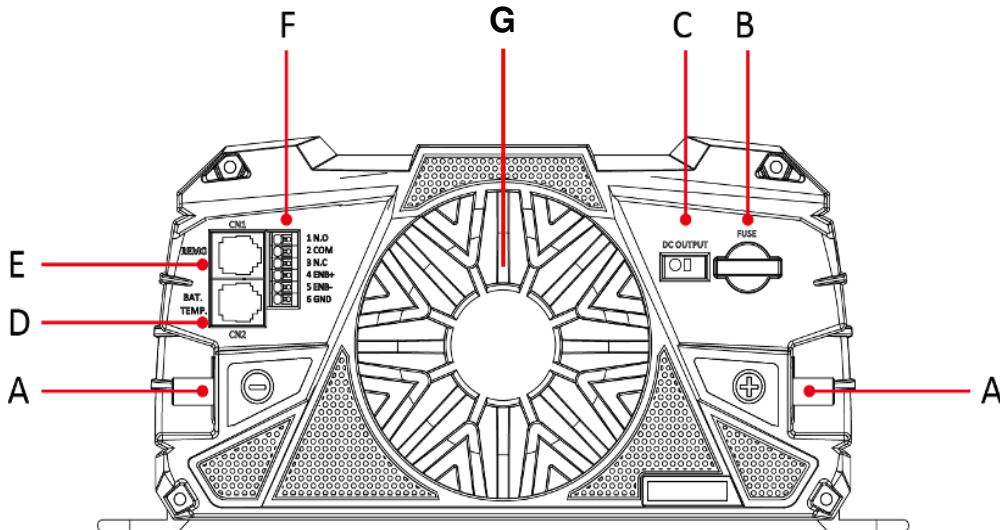
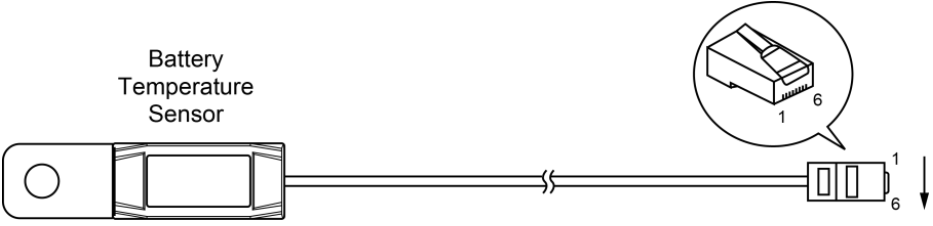
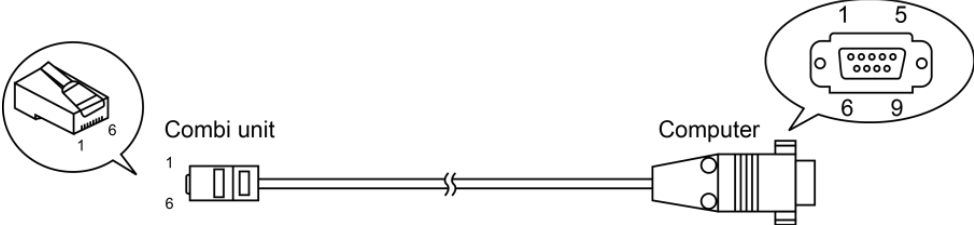

Fig. 5 : SC series Rear panel introduction

Rear panel																		
A	DC input connector	<p>Follow the instructions to connect the battery cables to the DC input terminals of the unit. The cables should be as short as possible (less than 6 feet / 1.8 meters ideally) so that they can handle the required current in accordance with the Electrical Codes and Regulations. The size of the cable should be thick enough to limit the voltage drop to less than 2% when carrying the maximum input current to prevent frequent low-input voltage warnings, and shutdown. UVP (Under Voltage Protection) warning may result if there is excessive voltage drop across the DC cables between the batteries and the unit. Increasing your DC cable size will help improve the situation.</p> <p>Batteries are capable of providing very large currents in case of short circuit. In case there is a short circuit in the cable run between the batteries and the input terminals of the unit, it will result in overheating / melting of the cables and consequent risk of fire and injury, to prevent possibility of this hazard, use Very Fast Acting DC Fuse in line with the positive cable. The fuse should be as close to the positive battery terminal as possible.</p> <p>The following sizes of cables and fuses are recommended for up to 6 ft. distance between the batteries and the unit.</p> <table border="1" style="width: 100%; border-collapse: collapse;"> <thead> <tr> <th style="text-align: center;">Model No.</th> <th style="text-align: center;">Wire AWG</th> <th style="text-align: center;">Inline Fuse</th> <th style="text-align: center;">External Fuse</th> </tr> </thead> <tbody> <tr> <td>SC1200-124 SC1200-224</td> <td style="text-align: center;">#6</td> <td style="text-align: center;">100A</td> <td style="text-align: center;">>100A</td> </tr> <tr> <td>SC1200-112 SC1200-212 SC2000-124 SC2000-224</td> <td style="text-align: center;">#2</td> <td style="text-align: center;">200A</td> <td style="text-align: center;">>200A</td> </tr> <tr> <td>SC2000-112 SC2000-212</td> <td style="text-align: center;">#2/0</td> <td style="text-align: center;">400A</td> <td style="text-align: center;">>400A</td> </tr> </tbody> </table>	Model No.	Wire AWG	Inline Fuse	External Fuse	SC1200-124 SC1200-224	#6	100A	>100A	SC1200-112 SC1200-212 SC2000-124 SC2000-224	#2	200A	>200A	SC2000-112 SC2000-212	#2/0	400A	>400A
Model No.	Wire AWG	Inline Fuse	External Fuse															
SC1200-124 SC1200-224	#6	100A	>100A															
SC1200-112 SC1200-212 SC2000-124 SC2000-224	#2	200A	>200A															
SC2000-112 SC2000-212	#2/0	400A	>400A															
B	Auxiliary DC output Fuse	Second charger limit current protection.																
C	Auxiliary DC output	SC series has a second charger output connector can be used to give a maintenance of a small battery. Maximum current is 20A.																

<p>D</p>	<p>Battery Temp. sensor port (RJ11) (Optional)</p>	<p>The unit is delivered with a battery temperature sensor. When the battery temperature is high, the charge voltage is automatically decreased.</p> <p style="text-align: center;">Battery Temperature Sensor</p> 
<p>E</p>	<p>Remote port (RJ11)</p>	<p>RS-232 Port : Serial port monitoring and control through computer interface.</p> 

Remote control terminal may be connected to a Form C relay for "FAULT" indication. When "FAULT" occurs, the relay switches.



conditions include Input under/over voltage, Output Short Circuit, Over Temperature, Over load and, Fan Failure.

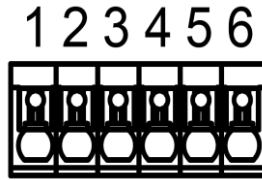

Fig. 7 : Remote control terminal

Item	Description	Item	Description
1	Dry contact (Normal Open)	4	Enable+ (ENB)
2	Common	5	Enable- (ENB)
3	Dry contact (Normal Closed)	6	Ground

RS-232 / Remote control port

F Remote control terminal and Dry terminal

Use 20 ~ 24 #AWG wire to connect the remote control terminals.

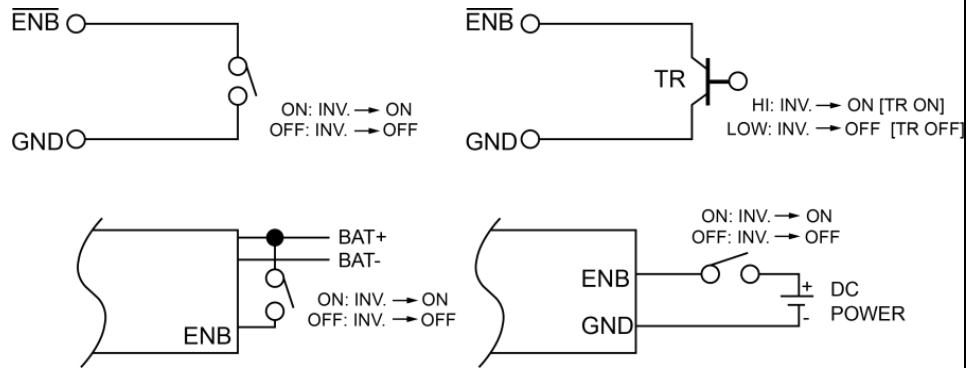

Fig. 8 : Wiring for remote control

Specifications of the Relay					
Maximum Voltage	Load	Contact Rating		Number of operations	Operating/Storage Temperature
		N.O.	N.C.		
250 VAC	Resistive	1 A	—	100,000	-30°C ~75°C
250 VAC	Resistive	—	1 A	—	
24 VDC	Resistive	1 A	—	—	
24 VDC	Resistive	—	1 A	—	

G

Fan speed control

The fan turned on by Load(%) or Temp(°C) as below chart:

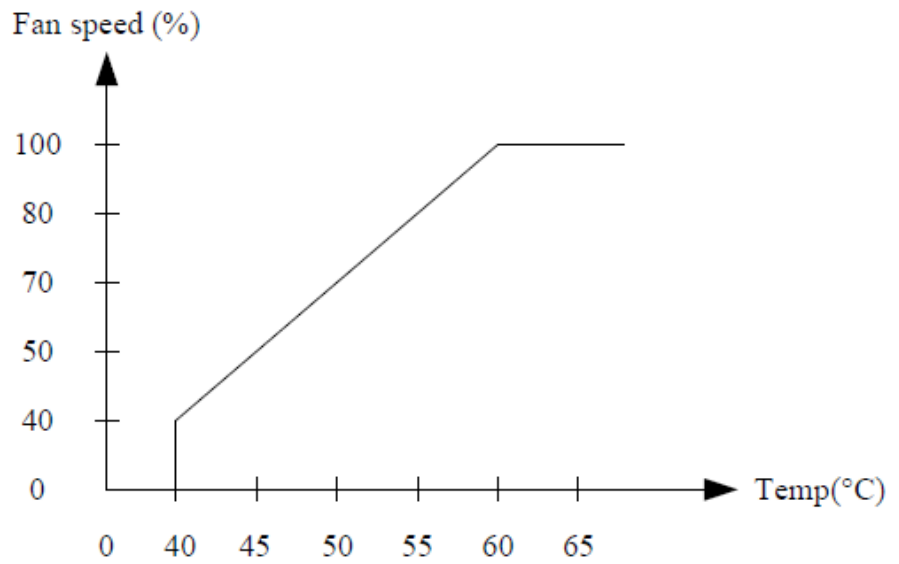
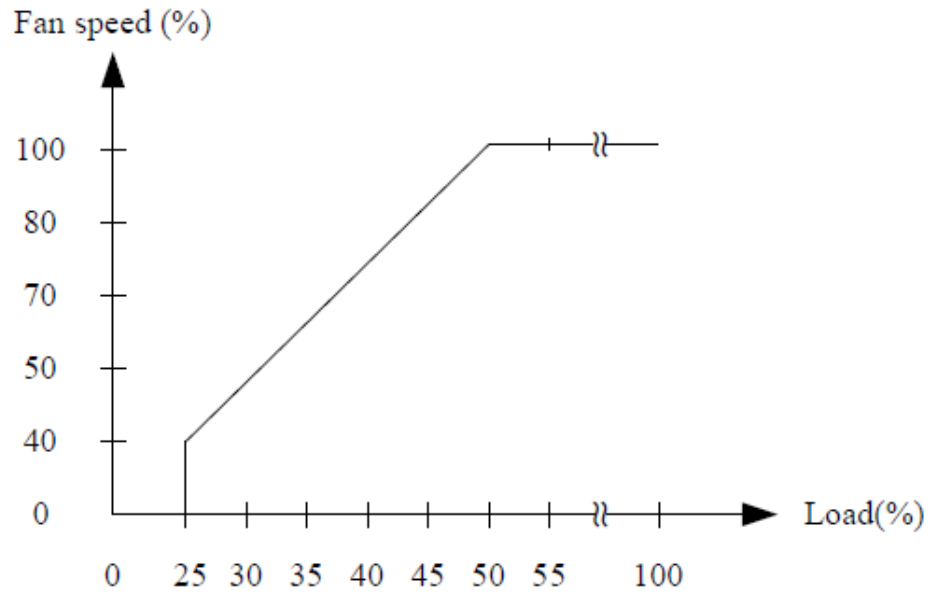

Note: the fan full speed(100%) turned when the status of over temperature, the circuit short, and the over load occur

3-4. Mounting Instruction

3-4-1. Wall Mount (For Marine)

Step 1. Use the screws to mount the Drip shield and the product on the wall.

Step 2. Please make sure the height from the ground to product at least 70 cm.

The bulkhead size requires at least 83 cm clearance each side of the inverter.

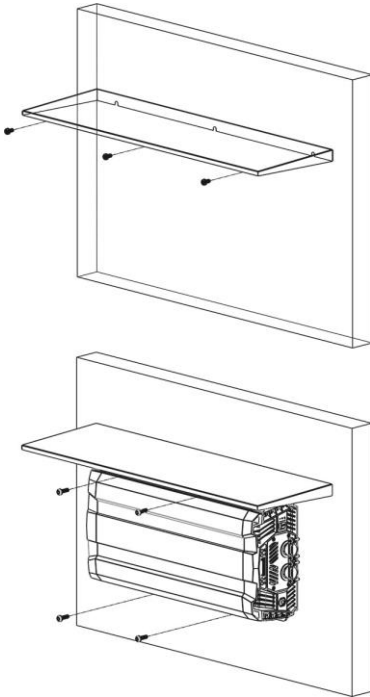

Fig. 6 : Wall mount step 1

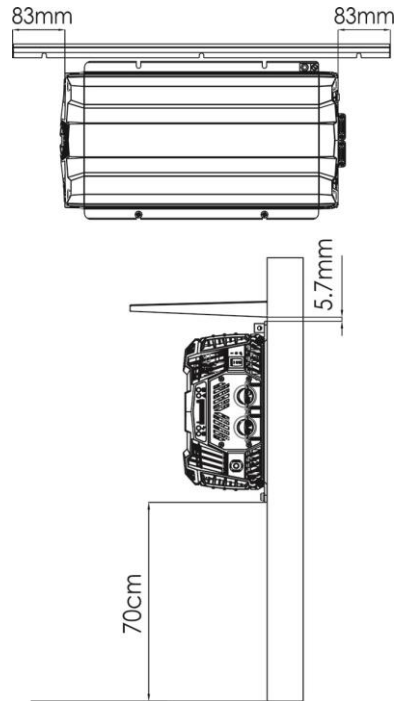

Fig. 7 : Wall mount step 2

3-4-2. Ceiling Mount (For Vehicle and Marine)

Use the screws to mount the product on the wall, and the product mounting requirement is as follow:

a. The mounting height from the ground to product requires at least 70 cm.

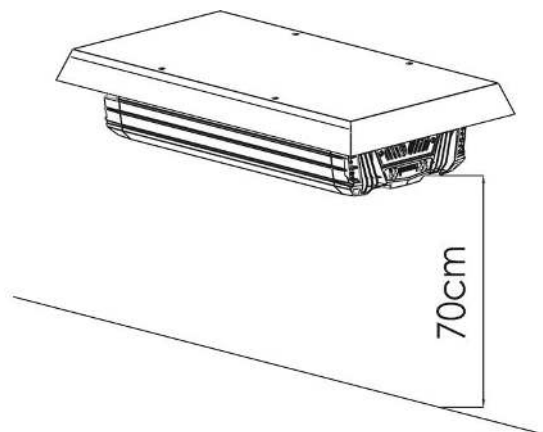
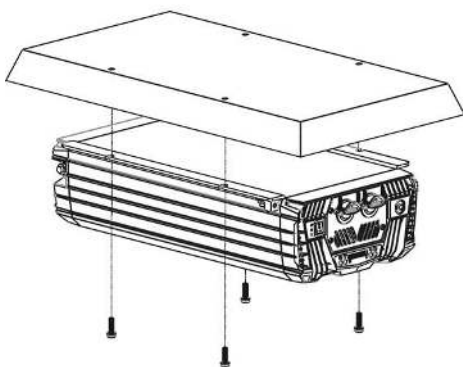

Fig. 8 : Ceiling mount

4. System Function Introduction

The SC series is a battery charger, a pure sine wave inverter and an AC transfer system in one compact enclosure. 1. The three-step charging function guarantees that the batteries are always charged 100% (User-selectable). 2. The pure sine wave inverter assures that the AC output voltage is perfectly reliable even when limited external AC power is available. 3. External AC power can be supplied by a public grid or a generator. 4. DC power can be delivered by charged batteries.

4-1. Battery charger introduction

The SC series can connect many types of battery (default setting is Gel), and user can adjust the parameters by dip switch to meet battery charging characteristics.

The following table shows some battery type charging setting.



CAUTION

Safety instruction: The setting for traction battery should never be used with a battery bank that consists of 2V GEL cells.

Battery Type Stage	GEL		Flooded	
	@12VDC	@24VDC	@12VDC	@24VDC
Bulk Voltage	14.4VDC	28.8VDC	14.7VDC	29.4VDC
Absorption Voltage	14.1VDC	28.2VDC	14.6VDC	29.2VDC
Float Voltage	13.6VDC	27.2VDC	13.4VDC	26.8VDC
Equalization Voltage	NOTE!	NOTE!	15.5VDC	31VDC

Table 14 : Battery type charging setting I

Battery Type Stage	AGM		Customer *	
	@12VDC	@24VDC	@12VDC	@24VDC
Bulk Voltage	14.7VDC	29.4VDC	12.0~16.0VDC	24.0~32.0VDC
Absorption Voltage	14.3VDC	28.6VDC		
Float Voltage	13.1VDC	26.2VDC		
Equalization Voltage	15.5VDC	31VDC		

*User can be setting the custom function voltage, but must use LCD remote control or RS-232.

Table 15 : Battery type charging setting II



NOTE

Gel batteries are not equalized. Hence, their Equalization Voltages are same as the Absorption Voltages.



WARNING!

When using the Custom setting, the Equalization voltage setting should not allow voltage lower than the Absorption Voltage setting. Also, the Equalization Voltage setting should not allow a setting higher than 2-volts (for 12V systems), or 4-volts (for 24V systems) above the Absorb Voltage setting.

4-1-1. Battery charging function description

The SC series Series is equipped with a PFC (Power Factor Corrected) and PI (Proportional-Integral) multistage battery charger. The PFC feature controls the amount of power used to charge the batteries to obtain a power factor as close as possible to 1 (or unity). This causes the battery charger to look like a resistor to the line (forces the charge current wave shape to mirror the voltage wave shape). The PI feature allows the charger voltage and current to change independently. These two features maximize the real power available from the AC power source (i.e., utility or generator), which translates into less power wasted and greater charging capabilities than most chargers today. When an AC source is connected to the AC input, the inverter begins monitoring for acceptable AC voltage. Once the AC voltage is accepted, the AC transfer relay closes the charge mode begins. After the charge mode begins, the inverter's battery voltage is monitored to determine the charging stage. The charger will skip the Bulk and Absorb charge stages and go directly to Final charging. However, if the incoming AC power is lost and returns within 2 minutes the charge mode returns to the charge stage it was in prior to losing AC input—regardless of the battery voltage.

The SC-1200/2000 three stages include an automatic 3-stage charging process: Bulk, Absorb, and Float Charge; and a manual Equalization (EQ) charge stage. The automatic 3-stage charge process provides complete recharging and monitoring of the batteries without damage due to overcharging. The EQ stage (requires a remote display to enable) is used to stir up stratified electrolyte and to reverse any battery plate sulfation that may have occurred. The AC input voltage falls below 90 VAC @1xx series / 180 VAC @2xx series— the charger will stop charging to help stabilize the incoming AC voltage. The Charge mode provides up to three separate charging stages: Bulk Charging, Absorb charging and Float Charge.

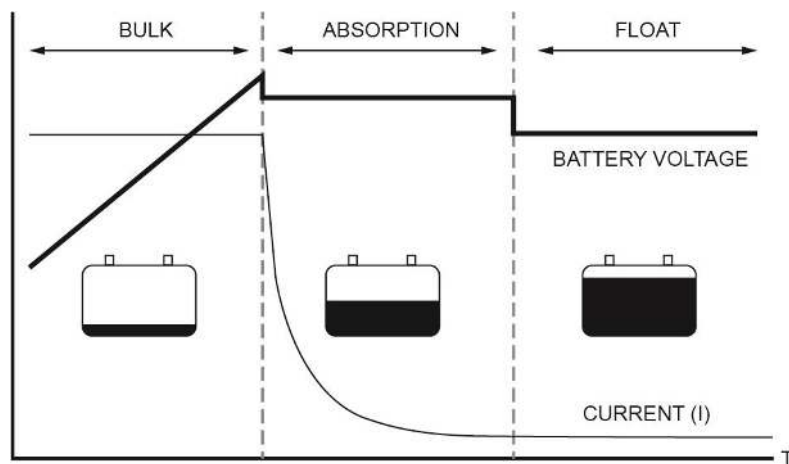

Fig. 9 : Three step charge system

4-1-2. Bulk charging

This is the initial stage of charging. While bulk charging, the charger supplies the battery with controlled constant current. The charger will remain in bulk charge until the absorption charge voltage (determined by the Battery Type selection) is achieved and charging time is 0.5~20 hours (determined by the battery **BulkMaxChaTime** selection), then switches to absorption charging.

4-1-3. Absorb charging

This is the second charging stage and begins after the absorb voltage has been reached. Absorb charging provides the batteries with a constant voltage and reduces the DC charging current in order to maintain the absorb voltage setting. Charging for 0.5~10 hours (determined by the Battery **AbsMaxCha Time** selection), then switches to final charging.

4-1-4. Float charging

The third charging stage occurs at the end of the absorb charging time. While final charging, the charge voltage is reduced to the final charge voltage (determined by the Battery Type selection*). In this stage, the batteries are kept fully charged and ready if needed by the inverter. The Float Charging stage reduces battery gassing, minimizes watering requirements (for flooded batteries), and ensures the batteries are maintained at optimum capacity.

4-1-5. Equalization charging

The intent of this charging procedure is active between absorb and final is to remove sulfation that formed as a result of the batteries being undercharged.

Another objective is to bring all cells to an equal state of charge. While Equalization charging, the charge voltage increase to 14.1V continue a cycle is 240 minute(automatic shutdown). The frequency of the equalizing charge is something that each battery manufacturer differs on. For example, some will recommend be applied every month or every ten cycles, while another will recommend every six months or every 20 cycles.

4-1-6. Temperature compensated charging

The unit is delivered with a battery temperature sensor. By installing this battery temperature sensor the charge voltages are automatically adapted for deviating temperature.

With a BTS (battery temperature sensor) installed, if the temperature around the BTS is below 20°C the absorb and float charge voltage increases, and if the temperature around the BTS is higher than 20°C, the absorb and float charge voltage decreases. See Fig.10 to determine how much the charge voltage changes (increases or decreases) depending on the temperature reading of the BTS. For example, the nominal absorb charge voltage for a flooded battery at 20°C on a 12-volt model is 14.6 VDC. If the battery temperature is 35°C, the absorb charge voltage would decrease to 14.225 VDC (14.6 - 0.375). If the temperature sensor is NOT installed, the charge voltages will not be automatically adjusted by temperature, but will be maintained at a temperature of 20°C. The life of the batteries may be reduced if they are subjected to large temperature changes when the BTS is not installed.

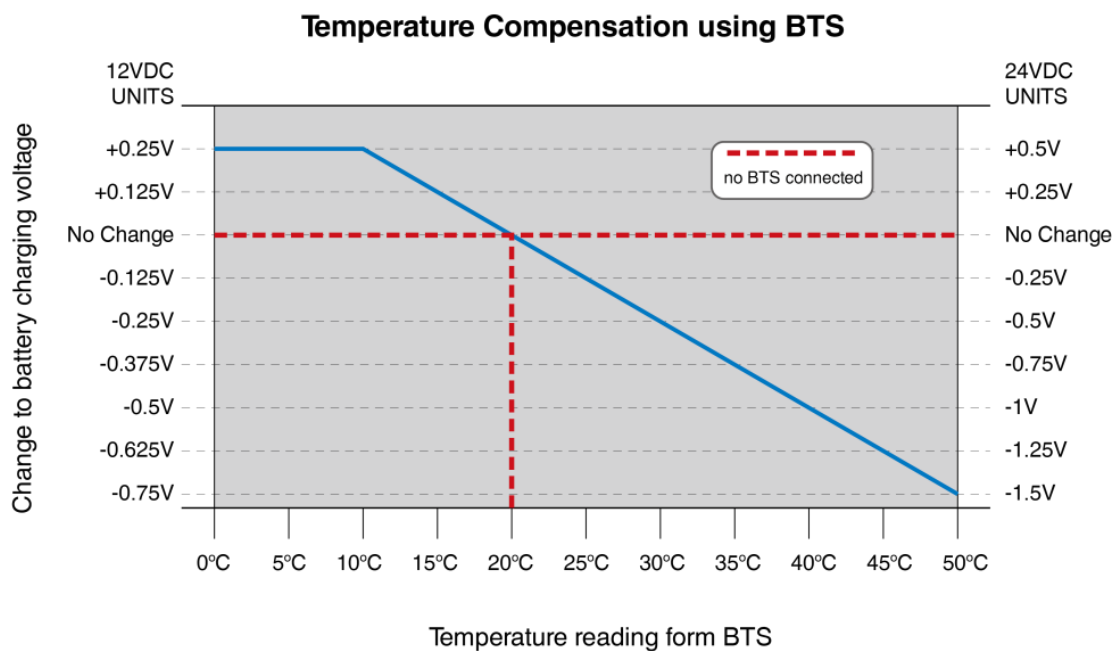

Fig. 10 : Temperature compensation using BTS

4-2. Operation mode introduction

The SC series is not just a combination of an inverter and a battery charger. There are many additional features which can be used to increase the total available AC power, even when external AC power is limited.

4-2-1. Basic operation description

When there is no external “AC input” power available, the inverter of the unit provides AC power output load from the batteries. There is no AC power available on the “AC output load”. See Fig. 11.

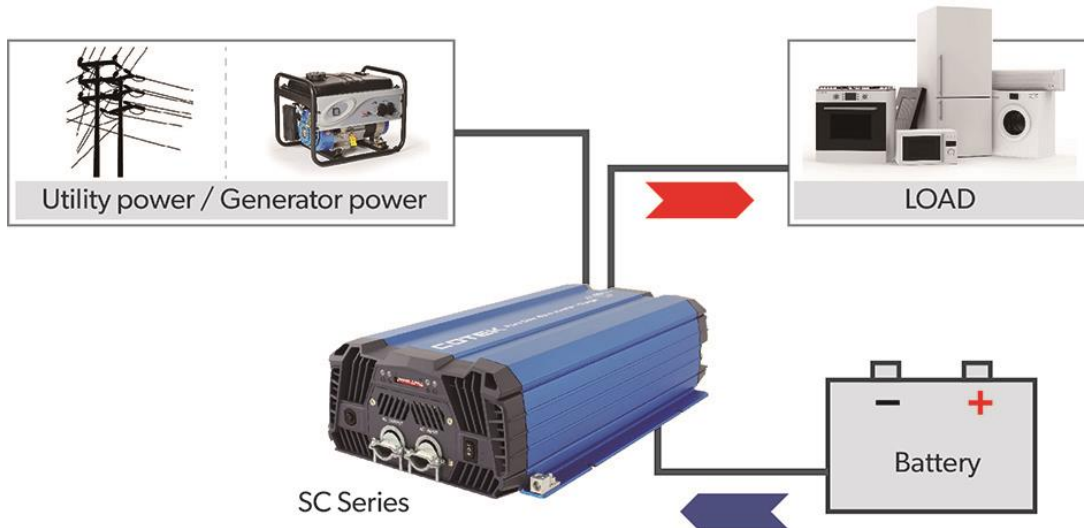

Fig. 11 : Inverter mode

When external AC power comes available, the transfer relay switches on. See Fig.12. Both outputs as well as the battery charger are supplied by the external AC power. The batteries are recharged now.

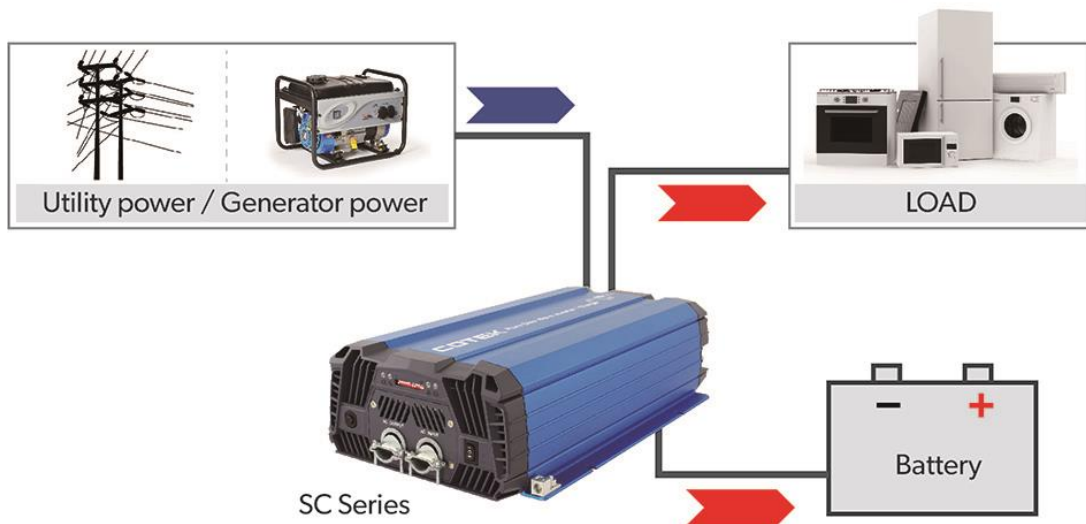

Fig. 12 : Charger mode

4-2-2. Power sharing function

Here the Power Sharing level is set to a 30 Amps while the AC output loads consume a total of 20Amps. This means that only $30 - 20 = 10$ Amps is left over for charging. With 12V batteries 120 VAC this will result in a maximum charge current of approx. 100A DC. See Fig. 13.

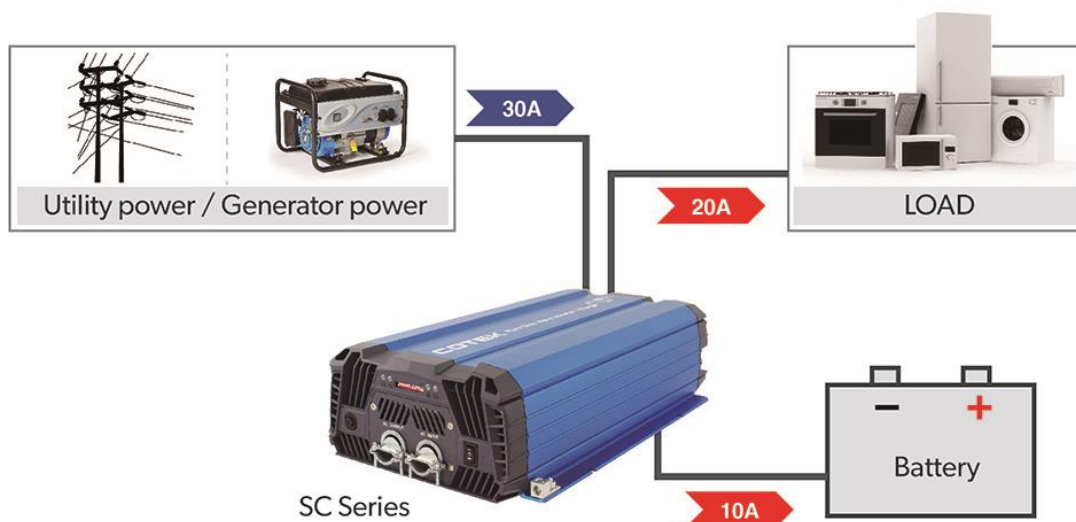

Fig. 13 : Power Sharing Function I

The Power Sharing level can be set by means only remote control locally on the unit. When the total connected AC load reaches the level of the Power Sharing setting (20A), there will be no power left over to charge the battery. This means that the charge current of the unit will be reduced to 0A. See Fig. 14.

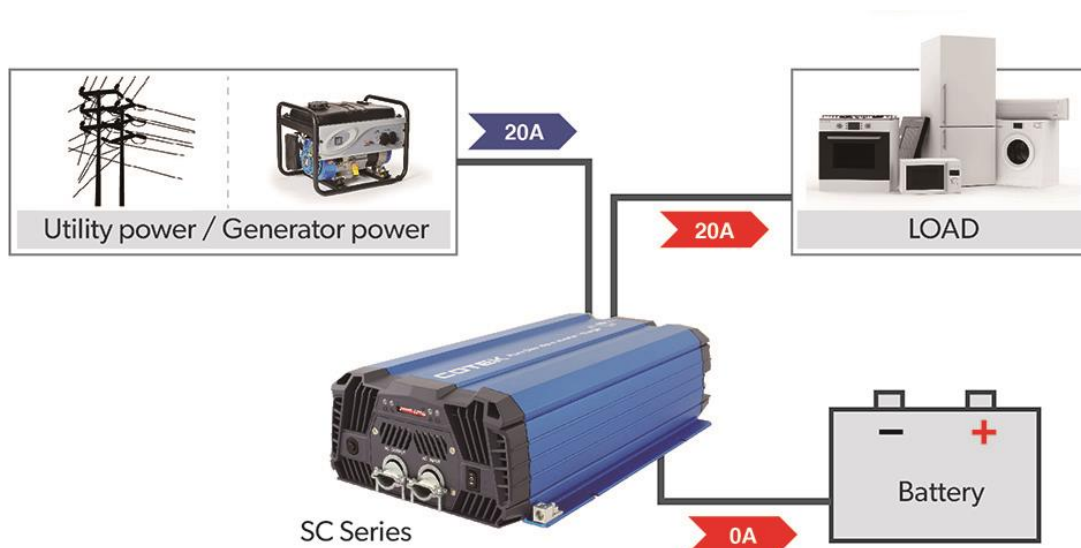

Fig. 14 : Power Sharing Function II

4-2-3. Generator function

If the demand for AC power still increases, the external AC circuit breaker may still trip if nothing is done. This problem can be solved by the Generator function. If the total demand for energy exceeds the maximum external power supply, energy can be added to the AC outputs load by means of the inverter. This appliance can be automatically connected in parallel with the external power supply.

See Fig. 15. Here the AC-input is still limited to 20 Amps. This is not enough to supply the total load (27A) connected to the AC output load.

The inverter will supply the remaining $27 - 20 = 7A$. This means that the restricted amount of external AC power will be compensated by energy which is stored in the batteries.

Later, when the AC load has dropped below the setting of the Power sharing function again, the battery charger of the unit will commence to recharge the batteries.

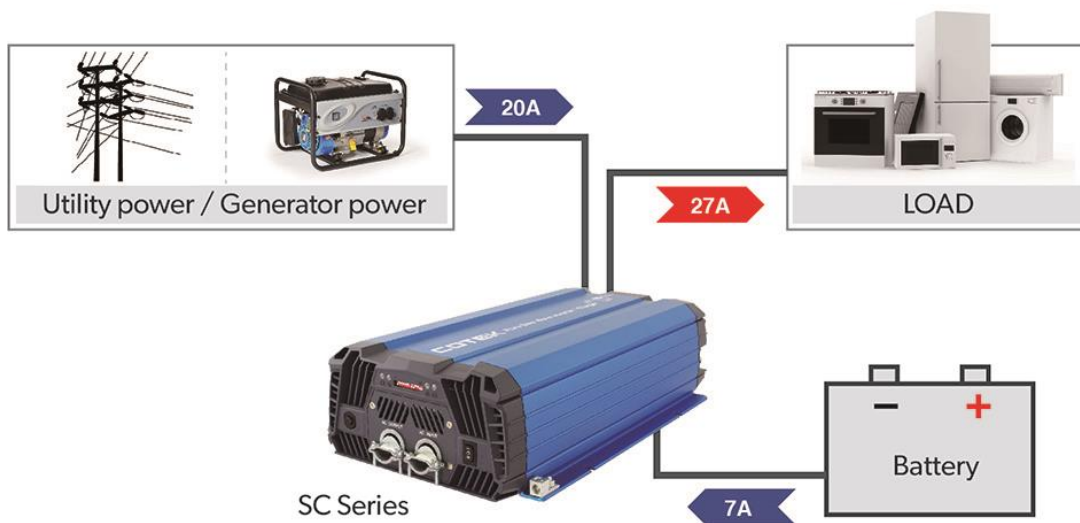

Fig. 15 : Generator Function

4-2-4. Power Support function

With the adjustable AC input current limit function, Power Support function of the SC inverter will trigger OLP (over-load protection) when the output power is over loaded. It can protect the input AC power device such as the utility or generator power system.

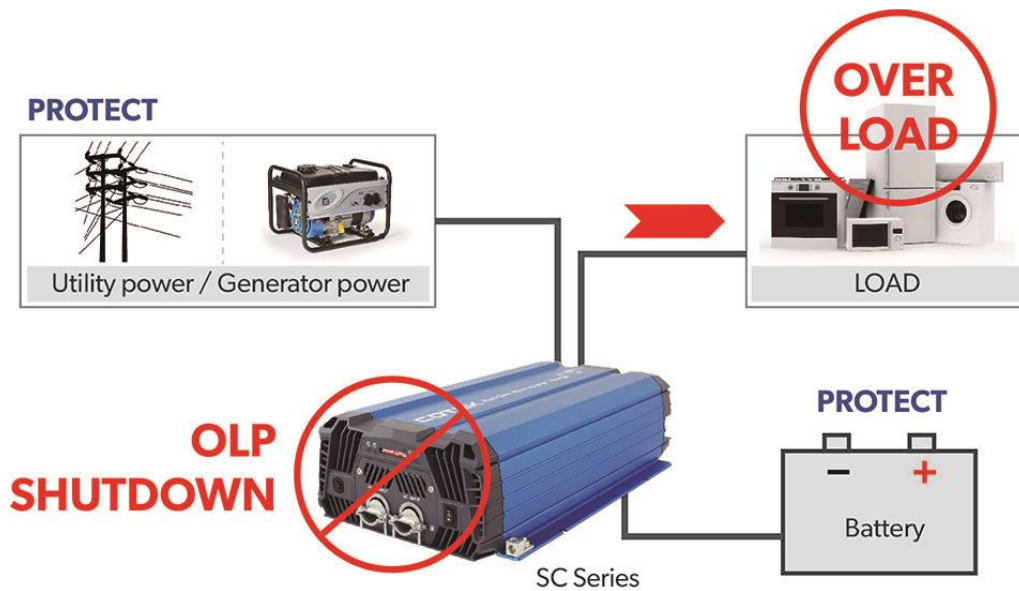

Fig. 16 : Power Support Function



CAUTION

For safety unit the transfer relay is immediately switched off when incoming AC power fails in operation so that there will never be a high voltage on the shore cable inlet when it is not connected.

5. Trouble Shooting

Status	LED Indicator	Buzzer states	Status	Solution
Green	— — — Slow Blink	Two Short	Over Temperature Protection (OTP)	1. Improve ventilation. Make sure ventilation openings in inverter are not obstructed. 2. Reduce ambient temperature.
	••••• Fast Blink	One Short	Under Temperature Protection (UTP)	1. Increase ambient temperature.
Orange	— — — Slow Blink	N/A	Grid Over / Under Voltage Protection	1. Make sure AC input is within 90Vac ~ 132Vac (110V system) or 180Vac~264Vac (220V system).
	••••• Fast Blink	N/A	Grid Over Current Protect	1. Turn off the load and make sure there is no short circuit inside the load circuit. 2. Check the setup value of AC input current limit (Dip Switch S4,S5,S6). 3. Re-turn on the unit manually.
	————— Solid	N/A	Phase or Frequency Failure	1. Make sure AC input frequency matches the Unit output frequency.
Red	— — — Slow Blink	Four Short	Battery Under Voltage Protection	1. Check DC input voltage. Increase DC input voltage. 2. Check DC input connection and wiring cable. 3. Recharge battery.
	••••• Fast Blink	Three Short	Battery Over Voltage Protection	1. Check DC input voltage. Reduce DC input voltage.
	————— Solid	Five Short	Over Load (101%~115%) Protection	1. Reduce load in case of restart failed. 2. Re-turn on the unit manually.
	N/A	Over Load (>115%) / Short Circuit Protection		

Table 16 : INV./CHR. Mode Trouble Shooting

6. IMPORTANT SAFETY INSTRUCTIONS for the marine application based on the standard code of UL 458

SAVE THESE INTRUCTIONS: This manual contains important safety and operating procedures.

- CAUTION – To reduce risk of injury, charge only AGM, GEL, Lithium battery, Lead-acid type rechargeable batteries. Other types of batteries may burst causing personal injury and damage.

2. Do not expose charger to rain or snow.
3. Use of an attachment not recommended or sold by the marine unit manufacturer may result in a risk of fire, electric shock, or injury to persons.
4. Do not disassemble marine unit; take it to a qualified serviceman when service or repair is required. Incorrect reassembly may result in a risk of electric shock or fire.
5. To reduce risk of electric shock, unplug marine unit from outlet before attempting any maintenance or cleaning. Turning off controls will not reduce this risk.
6. **WARNING – RISK OF EXPLOSIVE GASES.**
 - **WORKING IN VICINITY OF A LEAD-ACID BATTERY IS DANGEROUS.**
BATTERIES GENERATE EXPLOSIVE GASES DURING NORMAL BATTERY OPERATION. FOR THIS REASON, IT IS OF UTMOST IMPORTANCE THAT EACH TIME BEFORE SERVICING THE UNIT IN THE VICINITY OF THE BATTERY, YOU READ THIS MANUAL AND FOLLOW THE INSTRUCTIONS EXACTLY.
 - To reduce risk of battery explosion, follow these instructions and those published by battery manufacturer and manufacturer of any unit you intend to use in vicinity of battery. Review cautionary marking on these products and on engine.
7. **PERSONAL PRECAUTIONS**
 - Someone should be within range of your voice or close enough to come to your aid when you work near a lead-acid battery.
 - Have plenty of fresh water and soap nearby in case battery acid contacts skin, clothing, or eyes.
 - Wear complete eye protection and clothing protection. Avoid touching eyes while working near battery.
 - If battery acid contacts skin or clothing, wash immediately with soap and water. If acid enters eye, immediately flood eye with running cold water for at least 10 min and get medical attention immediately.
 - NEVER smoke or allow a spark or flame in vicinity of battery or engine.
 - Be extra cautious to reduce risk of dropping a metal tool onto battery. It might spark or short-circuit battery or other electrical part that may cause explosion.
 - Remove personal metal items such as rings, bracelets, necklaces, and watches when working with a lead-acid battery. A lead-acid battery can produce a short-circuit current high enough to weld a ring or the like to metal, causing a severe burn.
 - NEVER charge a frozen battery.
 - If necessary to remove battery from vessel, always remove grounded terminal from battery first. Make sure all accessories in the vessels are off, so as not to cause an arc.
 - Be sure area around battery is well ventilated.

- Clean battery terminals. Be careful to keep corrosion from coming in contact with eyes.
- Study all battery manufacturer's specific precautions such as removing or not removing cell caps while charging and recommended rates of charge
- Add distilled water in each cell until battery acid reaches level specified by battery manufacturer. This helps purge excessive gas from cells. Do not overfill. For a battery without cell caps, carefully follow manufacturer's recharging instructions.

8. MARINE UNIT LOCATION

- Locate marine unit away from battery in a separate, well ventilated compartment.
- Never place marine unit directly above battery; gases from battery will corrode and damage marine unit.
- Never allow battery acid to drip on marine unit when reading gravity or filling battery.
- Do not operate marine unit in a closed-in area or restrict ventilation in any way.

9. DC CONNECTION PRECAUTIONS

Connect and disconnect DC output connections only after setting any marine unit switches to off position and removing AC cord from electric outlet or opening AC disconnect.

10. EXTERNAL CONNECTIONS TO CHARGER SHALL COMPLY WITH THE UNITED STATES COAST GUARD ELECTRICAL REGULATIONS (33CFR183, SUB PART I).

11. GROUNDING INSTRUCTIONS – This marine unit should be connected to a grounded, metal, permanent wiring system; or an equipment-grounding conductor should be run with circuit conductors and connected to equipment-grounding terminal or lead on unit. Connections to unit should comply with all local codes and ordinances.

7. Warranty

We guarantee this product against defects in materials and workmanship for a period of 24 months from the date of purchase and will repair or replace any defective Combi units if you directly returned them to us with postage paid.

This warranty will be considered void if the unit has been misused, altered, or accidentally damaged. COTEK is not liable for anything that occurs as a result of the user's fault.

COTEK

No.33, Sec. 2, Renhe Rd., Daxi Dist., Taoyuan City 33548, Taiwan

Phone : +886-3-3891999 FAX : +886-3-3802333

[http : // www.cotek.com.tw](http://www.cotek.com.tw)

2018.10_A0