

Profile Wizard

In the MATE3s system display, the **Profile Wizard** allows quick setup of parameters that apply to all systems. The **Profile Wizard** is reached from the **Main Menu** as shown in **B**.

The Profile Wizard is useful for rapid setup of multiple parameters including date, time, battery charging, AC source size and limits, and system type. It can also configure functions such as **High Battery Transfer** and **Grid Use** times. Note that the last two items are not available if the System Type is set to **Off Grid**.

NOTE: The Wizard does not configure the entire system. It does not select AC input modes for the Radian inverter, parameters for automatic generators, or "fully charged" parameters if the FLEXnet DC battery monitor is in use. If settings are made in the wrong order, the Wizard can overwrite some customized settings. See the system display literature for more information.

The firmware revision of all devices can be confirmed by navigating from the **Main Menu** as shown in **A**. Upgrades to the firmware revision can be downloaded from the OutBack website www.outbackpower.com.

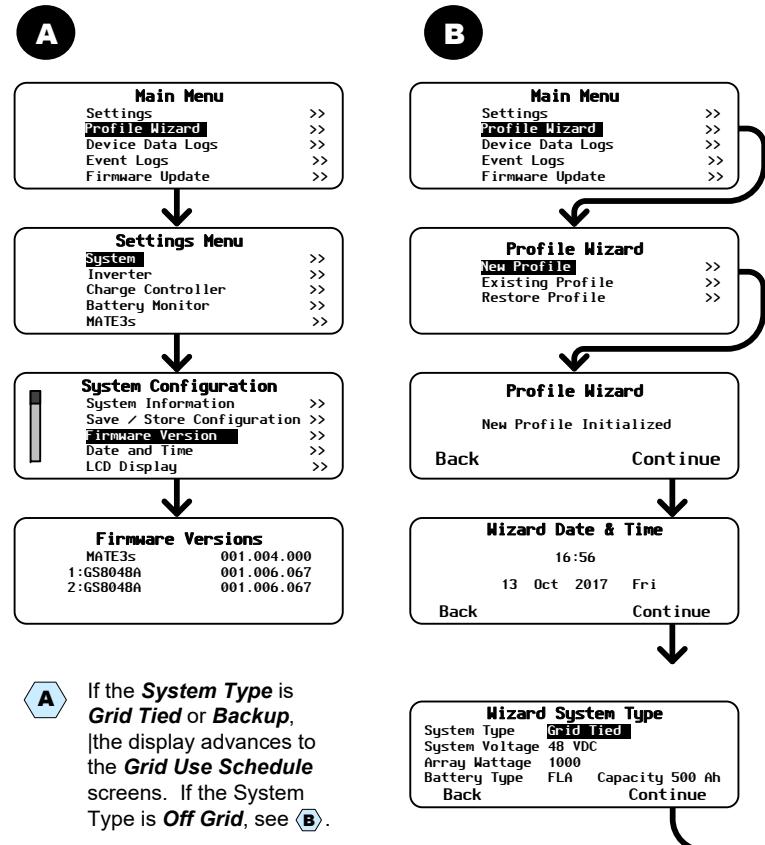

A If the **System Type** is **Grid Tied** or **Backup**, [the display advances to the **Grid Use Schedule** screens. If the System Type is **Off Grid**, see **B**.

B If the FLEXnet DC is installed, the display advances to the **Shunt** screens. If the FLEXnet DC is not installed, see **C**.

C This advances the display to the **Setup Complete** screen.

Date and Revision
September 2019, Revision C



CAUTION: Equipment Damage

These procedures should be done by a qualified installer who is trained on programming inverter power systems. Failure to set accurate system parameters could potentially cause equipment damage. Damage caused by inaccurate programming is not covered by the limited system warranty.



IMPORTANT

- ❖ Ensure all settings are correct for the system. The Profile Wizard can be used for rapid setup. For Grid Support functions it may be necessary to load a .GIP file.
- ❖ Verify the firmware revision of all OutBack devices before use. The Radian inverter and system display may not communicate or operate correctly unless their firmware is above a specified revision number.
- ❖ For firmware and .GIP file installation, see the *Installation Manual*. For settings and functions, see the *Operator's Manual*.



WARNING: Fire/Explosion Hazard

Do not place combustible or flammable materials within 12 feet (3.7 m) of the equipment. This unit employs mechanical relays and is not ignition-protected. Fumes or spills from flammable materials could be ignited by sparks.



WARNING: Personal Injury

Use safe lifting techniques and standard safety equipment when working with this equipment.



IMPORTANT:

- ❖ Check all connections for tightness. They may have loosened in transport.
- ❖ Before operating, perform a complete charge cycle until the FN-DC registers a full battery bank.
- ❖ Clearance and access requirements may vary by location. Maintaining a 36" (91.4 cm) clear space in front of the system for access is recommended. Consult local electric code to confirm clearance and access requirements for the specific location.

If System Type is Grid Tied or Backup...

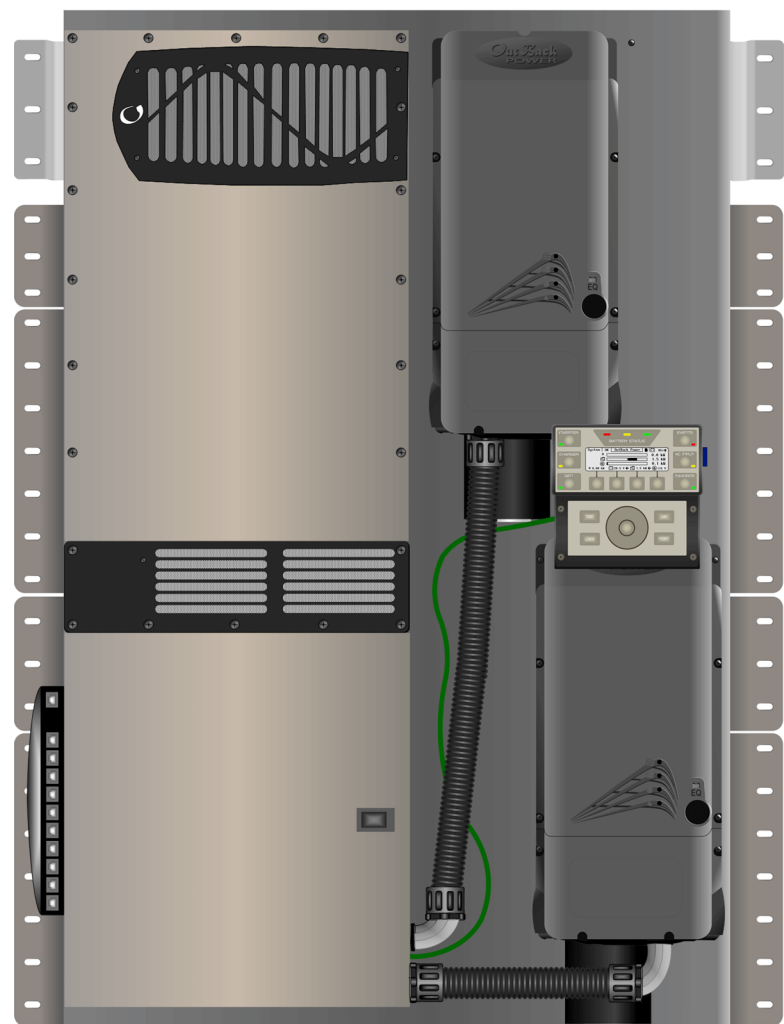
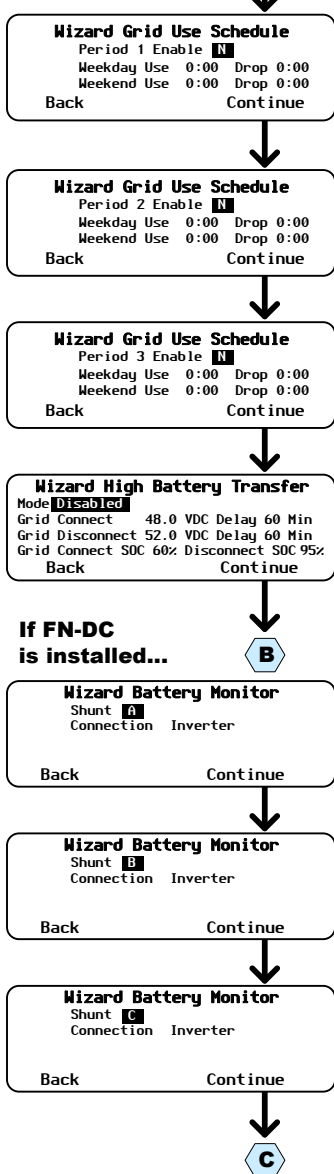

Components Included (components vary with model)

Inverter/Charger with GS Load Center	GS8048A GS4048A
Charge Controller	FM100-300VDC-AFCI
System Display and Controller	MATE3s (with FW-MB3-S mounting bracket)
Communications Manager	HUB10.3
Battery Monitor	FLEXnet DC (FN-DC)
Remote Temperature Sensor (RTS)	
Wall Mount Bracket	
Pre-wired Back Plane	

Customer-Supplied Components

AC Source	Utility Grid or AC Generator
Main Electrical Panel (or overcurrent device for the AC source)	
Electrical Distribution Subpanel (Load Panel)	
Photovoltaic (PV) Array and Combiner	
Battery Bank	



Masters of the Off-Grid.™
First Choice for the New Grid.

IMPORTANT:
Not intended for use with life support equipment.



OPTICS RE Compatible



NOTE: Working gloves are strongly recommended when performing installation steps.

- 1 Ensure the mounting surface is strong enough to handle 3 times the total weight of all the components. Add plywood or other reinforcing material as necessary to strengthen the surface.
- 2 Attach the wall bracket. Center the mounting holes on the wall studs. Use all 6 mounting screws to secure the bracket.
- 3 Lift the inverter high enough that the inverter bracket is above the wall bracket.
- 4 Lower the inverter so that the top of the back plane flange slips into the wall bracket. Ensure the unit is centered on the wall bracket.
- 5 Install the mounting screws. See illustration below for preferred locations for maximum mounting strength.

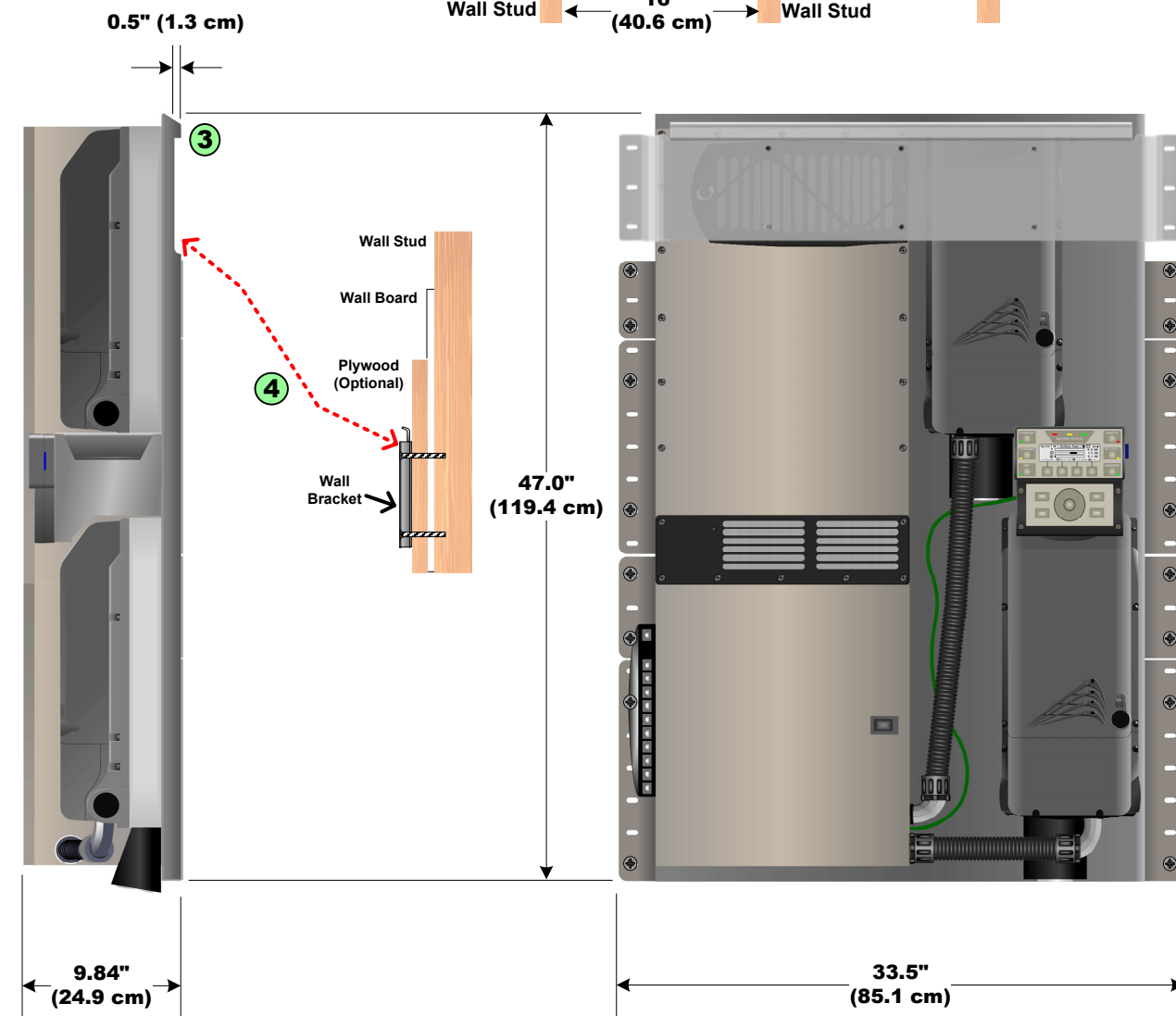
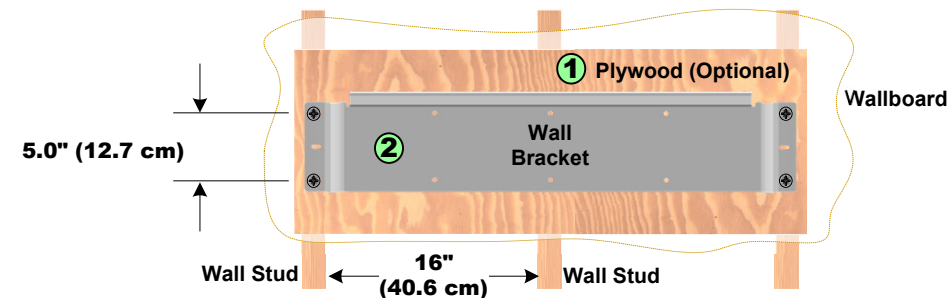

5 Preferred screw locations are depicted here

AC Wire Sizes and Torque Values

Wire Size		Torque	
AWG	mm ²	In-lb	Nm
#14 to #10	2.5 to 6	20	2.3
#8	10	25	2.8
#6 to #4	16 to 25	35	4.0
#3	35	35	4.0
#2	35	40	4.5
#1	50	50	5.6
1/0	70	50	5.6

OutBack recommends that conductors be #6 AWG THHN copper, or larger, rated to 75°C (minimum) unless local code requires otherwise.

Minimum DC Cable based on the DC Circuit Breaker

Circuit Breaker	Cable Size	Torque	
		In-lb	Nm
60	#6 AWG (16 mm ²)	35	4.0
80	#4 AWG (25 mm ²)	35	4.0
125	1/0 (70 mm ²)	50	5.6
175	2/0 (70 mm ²)	225	25.4
250	4/0 (120 mm ²)	225	25.4

Torque Requirements

Circuit Breaker Stud	Torque	
	In-lb	Nm
M8	20	2.3
1/4 - 20	35	4.0
5/16 - 18	50	5.6
3/8 - 16	225	25.4

DC Plates	Torque	
	In-lb	Nm
Upper holes (+)	60	6.8
Lower holes (+)	50	5.6
Shunt Bolts (-) and GS-SBUS	60	6.8

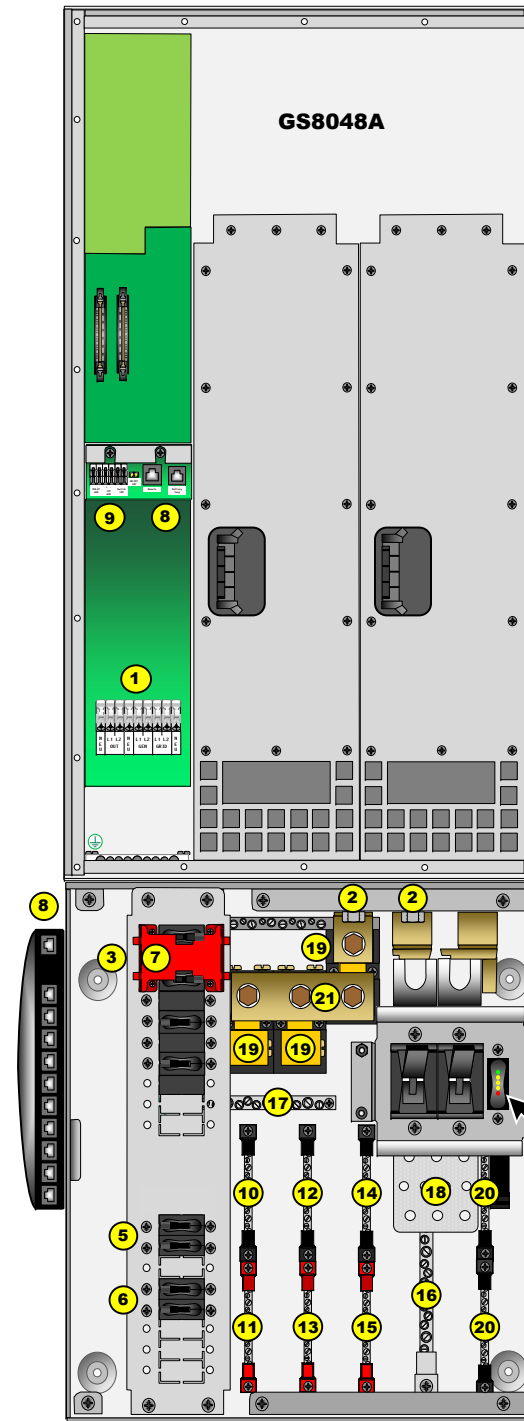

- 1 AC Terminals - Inverter
- 2 DC Terminals - Inverter
- 3 AC Circuit Breakers
- 4 DC Circuit Breakers
- 5 PV (Battery) Circuit Breakers
- 6 PV (Input) Circuit Breakers
- 7 Mechanical Interlock (Bypass)
- 8 Communication Ports
- 9 Auxiliary Terminals
- 10 AC OUT Bus Bar L1
- 11 AC OUT Bus Bar L2
- 12 GRID IN Bus Bar L1
- 13 GRID IN Bus Bar L2
- 14 GEN IN Bus Bar L1
- 15 GEN IN Bus Bar L2
- 16 AC Neutral
- 17 Ground
- 18 DC Positive (+) Plate (not used on FPR-4048A)
- 19 DC (FM100) Negative (-) Terminals
- 20 PV Negative (-) Bus Bars
- 21 DC Negative (-) Plate (GS-SBUS)

FN-DC

FN-DC LED Indicators	
Color	Battery State of Charge
Green	> 90% (blinks if charge parameters are met)
Yellow	≥ 80%
Yellow	≥ 70%
Yellow	≥ 60%
Red	≥ 60% off, < 60% solid, < 50% blinks

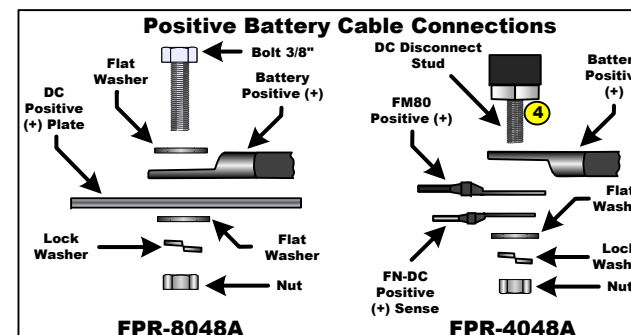

CAUTION: Equipment Damage
When connecting cables from the FP-Radian to the battery terminals, make sure to observe the proper polarity. Connecting the cables incorrectly can damage or destroy the equipment and void the product warranty.

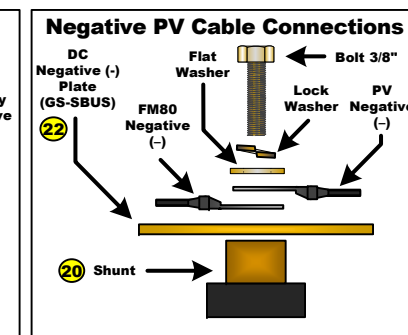
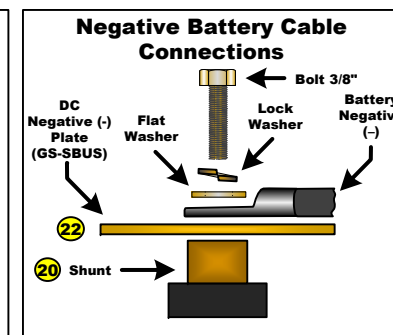

CAUTION: Fire Hazard
Before energizing, confirm that all hardware is installed as shown on the Installation page. Stacking battery terminal hardware in any other order can overheat the terminals.

Pre-startup Procedures:

1. Double-check all wiring connections.
2. Inspect the enclosure to ensure no debris or tools have been left inside.
3. Disconnect all AC loads at the backup (or critical) load panel.
4. Disconnect the AC input feed to the GSLC at the source.

To energize or start the OutBack devices:

1. Using a digital voltmeter (DVM), verify 48 Vdc on the DC input terminals by placing the DVM leads on **1a** and **1b**.

Confirm that the battery voltage is correct for the inverter and charge controller models.

Confirm the polarity.

CAUTION: Equipment Damage
Incorrect polarity will damage the equipment.

2. Turn on (close) the PV (battery) circuit breaker **1** for each charge controller.
3. Verify that the PV input for each charge controller is in the correct range of open-circuit voltage and confirm the polarity by:
 - a) placing the DVM leads on **2a** and **2d**, and
 - b) placing the DVM leads on **2b** and **2c**.
4. Turn on (close) the PV (input) circuit breakers. **2**
5. Turn on (close) the DC circuit breakers from the battery bank to the inverter. **3**
6. If the inverter is in the Off state, turn it On. **4**
7. Turn on (close) the AC output circuit breakers. **5**
8. Verify 120 Vac on the AC Output L1 TBB by placing the DVM leads on **3a** and **3c**.
9. Verify 120 Vac on the AC Output L2 TBB **3b** and **3c**.
10. Verify 240 Vac between the AC Output TBBs by placing the DVM leads on **3a** and **3b**.
11. Start the generator if appropriate. Verify 120/240 Vac on the terminals of the AC input sources.
12. Turn on the AC input feed to the GSLC at the source.
11. Verify 120 Vac on the GRID IN L1 TBB by placing the DVM leads on **4a** and **3c**.
12. Verify 120 Vac on the GRID IN L2 TBB **4b** and **3c**.
13. Verify 240 Vac between the GRID IN TBBs by placing the DVM leads on **4a** and **4b**.
14. Verify 120 Vac on the GEN IN L1 TBB by placing the DVM leads on **5a** and **3c**.
15. Verify 120 Vac on the GEN IN L2 TBB **5b** and **3c**.
16. Verify 240 Vac between the GEN IN TBBs by placing the DVM leads on **5a** and **5b**.
17. Turn on (close) the AC input circuit breakers. **6**
18. Turn on the AC disconnects at the backup (or critical) load panel and test the loads.

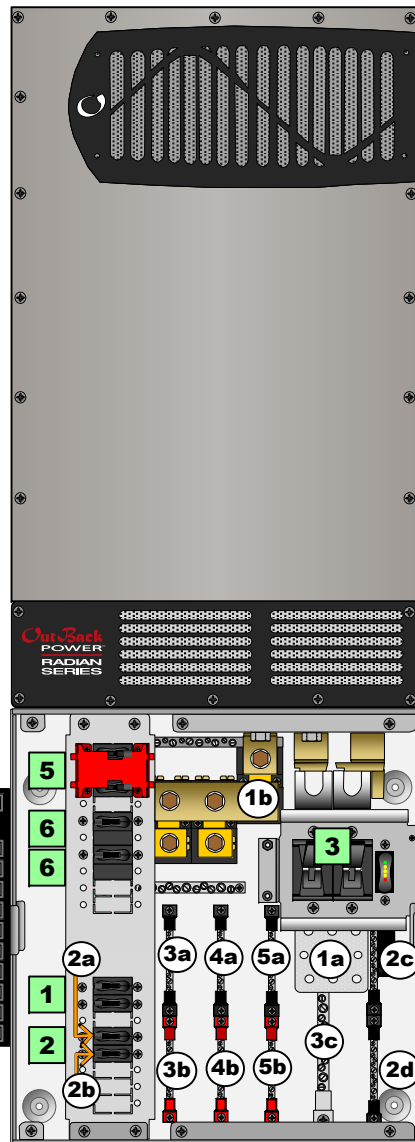

Test points 2a and 2b refer to the left terminal of each circuit breaker (the box lug).



NOTE:
The MATE3s system display retains factory default settings. Configuration for this system may be necessary before commissioning.

See **Setup and Programming** for more information.

Functional Test Points

Battery Voltage Test Points	1a 1b
PV Voltage Test Points	2a 2b 2c 2d
AC OUT Voltage Test Points (Terminal bus bar = TBB)	3a 3b 3c
GRID IN Voltage Test Points (Terminal bus bar = TBB)	4a 4b 3c
GEN IN Voltage Test Points (Terminal bus bar = TBB)	5a 5b 3c

WARNING: Burn Hazard
Internal parts can become hot during operation. Do not remove the cover during operation or touch any internal parts. Be sure to allow them sufficient time to cool down before attempting to perform any maintenance.

WARNING: Lethal Voltage
Review the system configuration to identify all possible sources of energy. Ensure ALL sources of power are disconnected before performing any installation or maintenance on this equipment. Confirm that the terminals are de-energized using a validated voltmeter (rated for a minimum 1000 Vac and 1000 Vdc) to verify the de-energized condition.

WARNING: Lethal Voltage
The numbered steps will remove power from the inverter and charge controllers. However, sources of energy may still be present inside the GSLC and other locations. To ensure absolute safety, disconnect ALL power connections at the source.

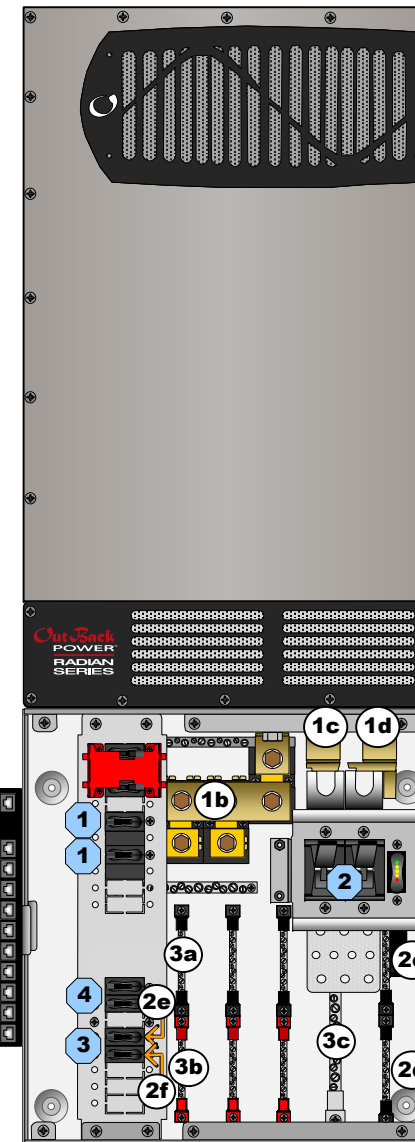

Test points 2e and 2f refer to the right terminal of each circuit breaker.

Functional Test Points

Battery Voltage Test Points	1a 1b 1c 1d
PV Voltage Test Points	2a 2b 2c 2d 2e 2f
AC OUT Voltage Test Points (Terminal bus bar = TBB)	3a 3b 3c

To de-energize or shut down the OutBack devices:

1. Turn off (open) the AC circuit breakers. **1**
2. Turn off (open) the DC circuit breakers for the battery. **2**
Wait 5 minutes for the devices to internally discharge themselves.
3. Turn off (open) the PV (input) circuit breakers. **3**
4. Turn off (open) the PV (battery) circuit breakers. **4**
5. Verify 0 Vdc on the first DC bus of the inverter by placing the voltmeter leads on **1b** and **1c**.
6. Verify 0 Vdc on the second DC bus by placing the voltmeter leads on **1b** and **1d**.
7. Verify 0 Vdc on one PV circuit by placing the voltmeter leads on **2e** and **2d**.
8. Verify 0 Vdc on the other PV circuit by placing the voltmeter leads on **2f** and **2c**.
9. Verify 0 Vac on the AC output circuit breakers by placing the voltmeter leads on **3a** and **3c**. Repeat this step for **3b** and **3c**.

AC Distribution Panel

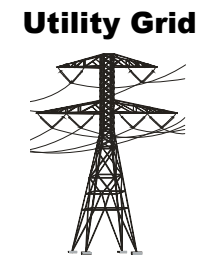

AC LEGEND

Neutral	N
HOT L1	L1
HOT L2	L2
Ground	⊕

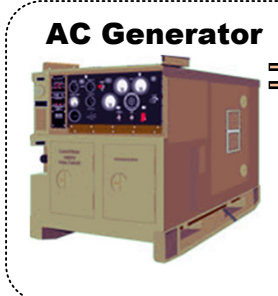
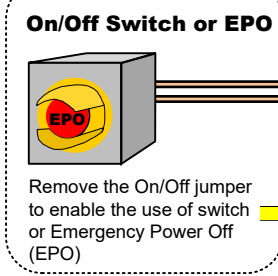

FPR-8048A wiring and external system

IMPORTANT:
Example only. Actual wiring may vary depending on system details and local electric code. Most factory wiring is not shown.

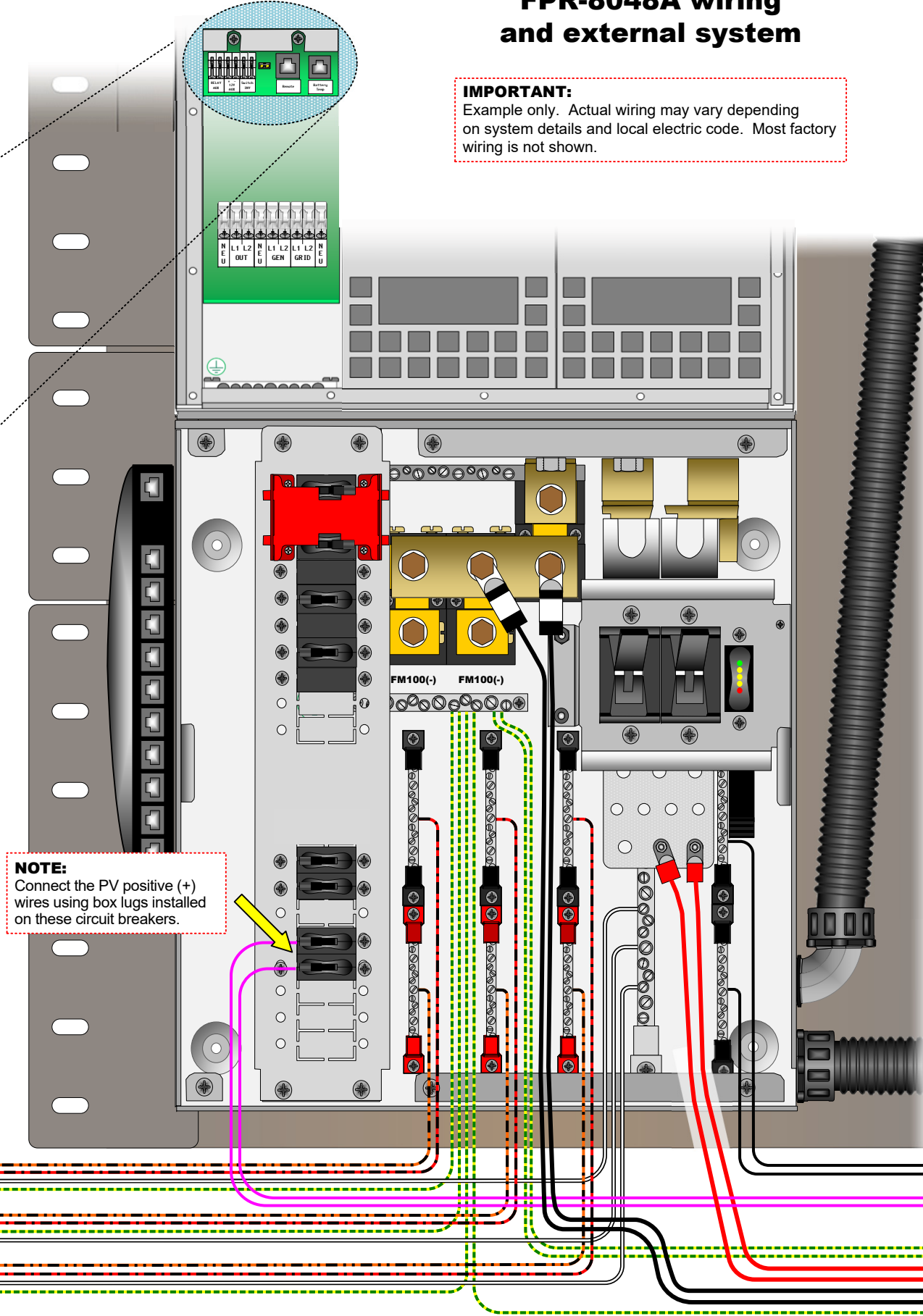

FPR-4048A wiring

The FPR-4048A follows the same wiring layout as the FPR-8048A with the following exceptions (depicted):

- No DC positive (+) plate is present. A single positive battery cable is used. The positive cable lug attaches to the base of the main DC disconnect (with the GFDI cable). See **Positive Battery Cable Connections** on the **Installation** page.
- A single battery negative (-) cable is used. It attaches to the far right shunt.
- A single PV negative cable (-) and bus bar are used.
- A single PV positive (+) cable is used. Connect it to the PV circuit breaker using a box lug.

