

COTEK

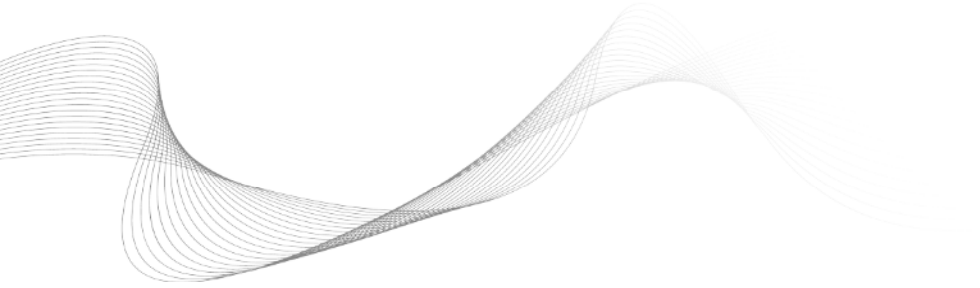

CX Series User's Manual

Advanced Converter / Charger

Legal Provisions

Copyrights 2016 COTEK Electronic IND. CO. All Rights Reserved.

Any part of this document may not be reproduced in any form for any purpose without the prior written permission of COTEK Electronic IND. CO. For the conditions of the permission to use this manual for publication, contact COTEK Electronic IND. CO., LTD. In all related COTEK product activities, Neither COTEK Electronic IND. CO., LTD. nor its distributors or dealers be liable to anyone for indirect, incidental, or consequential damages under any circumstances. Specifications are subject to change without notice. Every attempt has been made to make this document complete, accurate and up-to-date. COTEK Electronic IND. CO., LTD reserve the right to make changes without notice and shall not be responsible for any damages, including indirect, incidental or consequential damages, caused by reliance on the material presented, including, but not limited to, omissions, typographical errors, arithmetical errors or listing errors in the content material. All trademarks are recognized even if these are not marked separately. Missing designations do not mean that a product or brand is not a registered trademark.

Table of Content

1. IMPORTANT SAFETY INFORMATION	1
1-1. General Safety Precautions	1
1-2. Battery Precautions	2
2. FEATURES	3
2-1. Battery Charging Curve	4
2-2. Specification	6
2-3. Mechanical Drawings	9
3. PRODUCT DESCRIPTION	13
3-1. Configurations	13
3-2. S1 Setting	14
3-3. Charging Status LED Indicator	15
3-4. Failure Indicator	15
3-5. Pin Assignment of CN2 – For Alarms Signal & Fan Control	16
3-6. Sleep Mode	16
3-7. Pin Assignment of CN3 – For Temperature sensor & Remote control	16
3-8. Pin Assignment of CN4 – For Remote control	17
3-9. Pin Assignment of ESB Connectors – For CX1215/1225/1235	17
3-10. Temperature Compensation	17
3-11. Rescue Battery Curve	18
3-12. Battery Charger Selection	19
3-13. Battery Voltage setting suggestion	19
3-14. Fan speed duty description	20

4. INSTALLING CONVERTER / CHARGER	21
4-1. Battery charger connection diagram	23
5. TROUBLE SHOOTING	26
6. WARRANTY STATEMENT	27
6-1. Warning	27
6-2. Warranty	27

1. Important Safety Information



Warning!

Before installing or using CX series power converter, you need to read following safety information carefully.

1-1. General Safety Precautions

- 1-1-1. For indoor use, do not expose CX-Series Battery Charger to water, mist, snow, or dust. To reduce the risk of fire, do not cover or obstruct the ventilation enclosure.
- 1-1-2. To avoid the risk of fire and electric shocks, make sure that existing wiring is in good electrical condition and not undersized.
- 1-1-3. Do not charge non-rechargeable batteries.
- 1-1-4. Disconnect the AC Grid before making or breaking the connections to the battery.
- 1-1-5. Only the AC cord with IEC socket is allowed to plug to the battery charger.
- 1-1-6. Never charge a frozen battery.
- 1-1-7. If the AC cord is damaged do not attempt to use. It must be replaced or repaired by a qualified person.
- 1-1-8. Corrosive substances may escape from the battery during charging and damage delicate surfaces. Please store and charge in a suitable area.

1-2. Battery Precautions

- 1-2-1. If battery acid contacts your skin or clothing, wash it out with soap and water immediately.
- 1-2-2. If battery acid contacts your eyes, wash it out with cold running water for at least 20 minutes and get medical attention immediately.
- 1-2-3. Never smoke or make a spark or flame in the vicinity of the battery.
- 1-2-4. Do not drop metals on the battery.
The resulting sparks or short-circuits on the battery or other electrical parts may cause an explosion.
- 1-2-5. Remove personal metal items such as rings, bracelets, necklaces, and watches when operating with lead-acid batteries. It may cause short circuit and very high temperature, which can melt metal items.

2. Features

- Universal AC input with active PFC
- Compatible with Lead Acid, Li-ion, Gel and AGM batteries
- Support remote controller CR-1 as optional accessory
- Voltage / temperature compensation
- 2 stage fan speed control (Sleep mode)
- Output power OK signal
- Output alarm signal
- High efficiency and high reliability
- Built-in battery rescue function
- Built-in Extra Second Battery (ESB) output function
- Protection Short Circuit / Over Voltage / Over Temperature / Brown-out Protection
- Withstand 2G vibration test

2-1. Battery Charging Curve

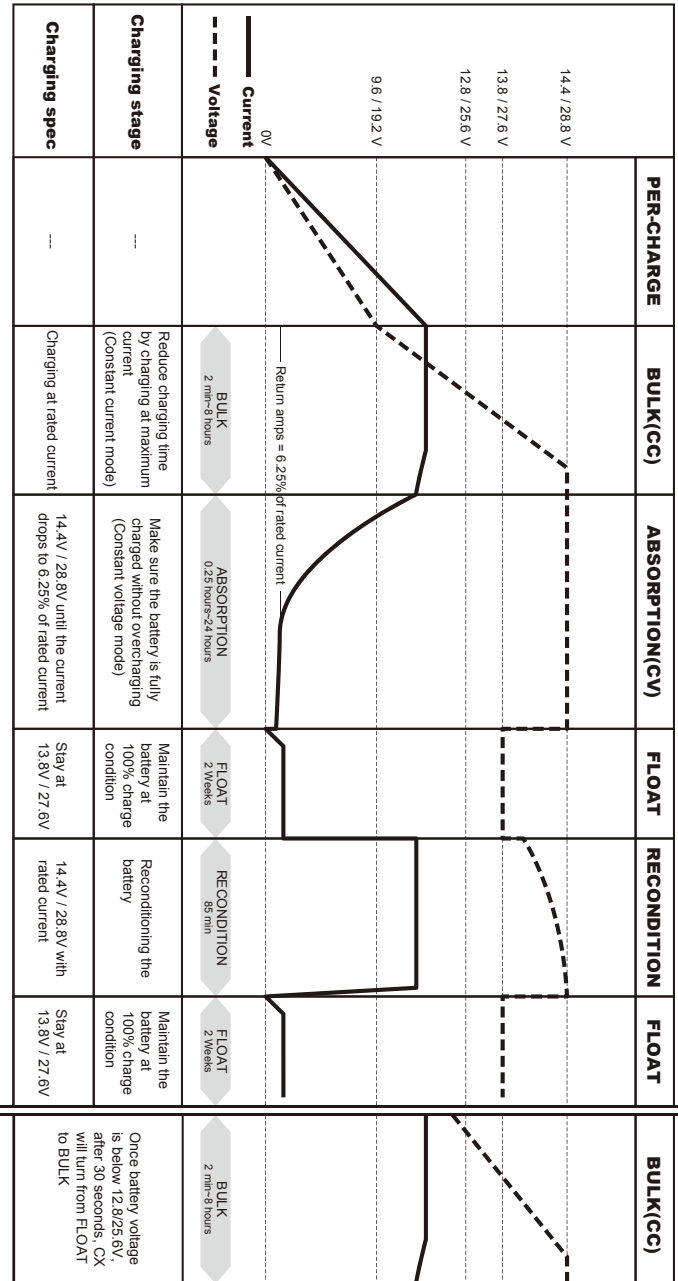

Figure 1. CX series Battery Charging Curve

2-1-1. Bulk Stage (Constant Current)

At the beginning of the charging process, the flat battery is charged at constant current (maximum charge current) until the battery voltage reaches the set charging voltage (Refer to 3-2 charging mode setting).

2-1-2. Absorption Stage (Constant Voltage)

The absorption charging duration will depend on the battery status.

Before moving to absorption stage, charger will wait for two minutes then charging at constant voltage until the battery is fully charged.

Once the battery is fully charged or the charging current is below 6.25% of the rated charging current for 15 minutes, then the absorption stage ends.

2-1-3. Float Stage

After absorption stage, the battery charger switches to float stage, maintains the battery at 100% charge without overcharging or damaging the battery. This means the charger can be left connected to the battery continuously.

2-1-4. Recondition stage

Every 14 days, the battery charger switches back to Bulk stage for 85 minutes in order to revive the battery. This prevents any fatigue symptoms such as sulphation.

2-2. Specification

Model		CX1215	CX1225	CX1235	CX1250	CX1280
Output	Battery Type	Lead Acid / Li-ion / Gel / AGM				
	Standard Boost Charge Voltage	14.4V / 14.7V (Select by S1 DIP switch)				
	Standard Float Charge Voltage	13.8V / 13.5V (Select by S1 DIP switch)				
	Main Rated Current	15A	25A	35A	50A	80A
	Main Output	1	2	2	3	3
	ESB Output	1	1	1	--	--
	ESB Output Voltage / Current	13.8V/2A	13.8V/2A	13.8V/2A	--	--
	Battery Charging Mode	3-stage charging capability IUOU				
	Isolation Type	Use active power MOSFET on each output terminal				
Single Output Current Limit	15A	25A	35A	40A	40A	
Input	Voltage Range	90~264VAC (Refer to 2-2-1 de-rating curve)				
	Frequency Range	47~63Hz				
	Power Factor (Typ.)	PF > 0.92 at full load				
	Efficiency (Typ.) at 230Vac	87%	87%	87%	87%	87%
Protection	Short Circuit	Current is reduced to < 1A continued 30sec., will operate 30 seconds then turn off				
	Over Voltage	17.5V \pm 1%, protection type: shut down output (recovery after resetting AC power ON)				
	Over Temperature	Charger Over Temperature 100 \pm 5°C detected by heat sink				
		52 \pm 5°C (Optional temperature sensor) Auto recovery after heat sink temperature goes down to 50 \pm 5°C				
Function	Alarm Signal	NC. / NO. Relay contact output (Please reference Alarms signal & Fan control)				
	Temp. Compensation	12V : -10mv / 0.5°C with COTEK temperature sensor 24V : -20mv / 0.5°C with COTEK temperature sensor				
	Sleep Mode	By Remote Controller and S1-4 DIP switch (Please refer to section 3-2)				
	Remote Controller	Support COTEK Remote Controller CR-1 (Refer to section 3-6 and 3-7)				
Environment	Working Temperature	-20~40°C (Refer to 2-2-2 de-rating curve)				
	Working Humidity	20~90% RH non-condensing				
	Temperature Coefficient	\pm 0.03% (0~50°C)				
	Vibration	10~500Hz, 2G 10min. / 1cycle period for 60min. each along X, Y, Z axes.				
Safety & EMC	Safety Standards	Certified EN 60335-1, EN 60335-2-29, UL458				
	Withstand Voltage	I/P-O/P: 4242VDC, I/P-FG: 1768VDC, O/P-FG: 707VDC				
	Isolation Resistance	I/P-O/P: 100M Ohms / 500VDC				
	EMC Standards	Certified EN 55022; EN 61204-3; EN 55014-1 Certified EN 61000-3-2; EN 61000-3-3; EN 61204-3; EN 61000-6-3 Certified EN 55024; IEC 61000-4-2, 3, 4, 5, 6, 8, 11; ENV 50204; EN 61000-6-1; EN 55014-2				
Others	Dimension (WxHxD)	183x72x243 mm		183x72x263 mm	213x77x272 mm	213x77x312 mm
	Packing	1.6 kg	1.7 kg	1.9 kg	3.1 kg	4.0 kg

Model		CX2415	CX2425	CX2440
Output	Battery Type	Lead Acid / Li-ion / Gel / AGM		
	Standard Boost Charge Voltage	28.8V / 29.4V (Select by S1 DIP switch)		
	Standard Float Charge Voltage	27.6V / 27V (Select by S1 DIP switch)		
	Main Rated Current	12.5A	25A	40A
	Main Output	2	3	3
	ESB Output	--	--	--
	ESB Output Voltage / Current	--	--	--
	Battery Charging Mode	3-stage charging capability IUOU		
	Isolation Type	Use active power MOSFET on each output terminal		
Single Output Current Limit	12.5A	25A	40A	
Input	Voltage Range	90~264VAC (Refer to 2-2-1 de-rating curve)		
	Frequency Range	47~63Hz		
	Power Factor (Typ.)	PF > 0.92 at full load		
	Efficiency (Typ.) at 230Vac	90%	90%	90%
Protection	Short Circuit	Current is reduced to < 1A continued 30sec., will operate 30 seconds then turn off		
	Over Voltage	35V ±1%, protection type: shut down output (recovery after resetting AC power ON)		
	Over Temperature	Charger Over Temperature 100 ±5°C detected by heat sink		
		52±5°C (Optional temperature sensor)		
	Auto recovery after heat sink temperature goes down to 50±5°C			
Function	Alarm Signal	NC. / NO. Relay contact output (Please reference Alarms signal & Fan control)		
	Temp. Compensation	12V : -10mv / 0.5°C with COTEK temperature sensor 24V : -20mv / 0.5°C with COTEK temperature sensor		
	Sleep Mode	By Remote Controller and S1-4 DIP switch (Please refer to section 3-2)		
	Remote Controller	Support COTEK Remote Controller CR-1 (Refer to section 3-6 and 3-7)		
Environment	Working Temperature	-20~40°C (Refer to 2-2-2 de-rating curve)		
	Working Humidity	20~90% RH non-condensing		
	Temperature Coefficient	±0.03% (0~50°C)		
	Vibration	10~500Hz, 2G 10min. / 1cycle period for 60min. each along X, Y, Z axes.		
Safety & EMC	Safety Standards	Certified EN 60335-1, EN 60335-2-29, UL458		
	Withstand Voltage	I/P-O/P: 4242VDC, I/P-FG: 1768VDC, O/P-FG: 707VDC		
	Isolation Resistance	I/P-O/P: 100M Ohms / 500VDC		
	EMC Standards	Certified EN 55022; EN 61204-3; EN 55014-1 Certified EN 61000-3-2; EN 61000-3-3; EN 61204-3; EN 61000-6-3 Certified EN 55024; IEC 61000-4-2, 3, 4, 5, 6, 8, 11; ENV 50204; EN 61000-6-1; EN 55014-2		
Others	Dimension (WxHxD)	183x72x243 mm	213x77x272 mm	213x77x312 mm
	Packing	1.6 kg	2.9 kg	3.9 kg

2-2-1. Charging Current vs. Ambient Temperature De-rating Curve

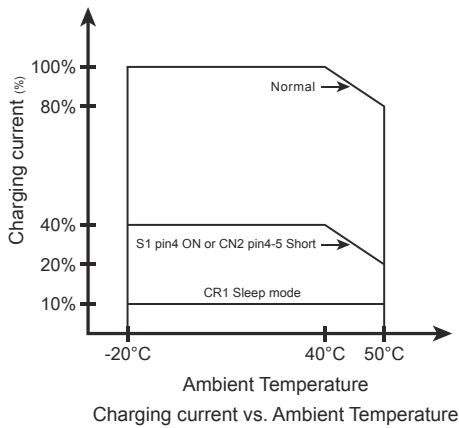

Figure 2. Charging current vs. Ambient temperature de-rating curve

2-2-2. Charging Current vs. Input Voltage Temperature De-rating Curve

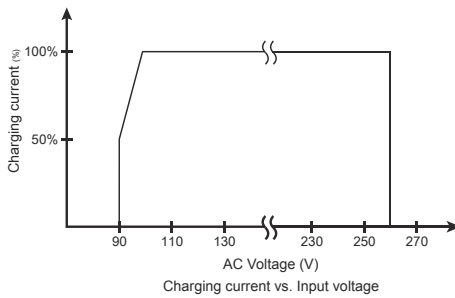

Figure 3. Charging current vs. Input voltage temperature de-rating curve

2-3. Mechanical Drawings

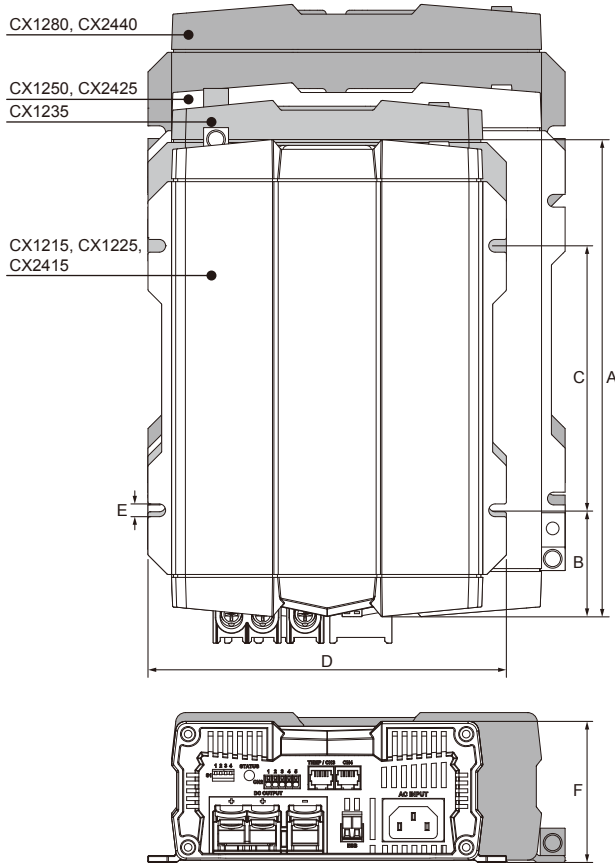

Figure 4. Mechanical Drawings

Model	A (mm)	B (mm)	C (mm)	D (mm)	E (mm)	F (mm)
CX1215	243	54.2	135.0	183	6.5	72
CX1225	243	54.2	135.0	183	6.5	72
CX1235	263	56.7	150.0	183	6.5	72
CX1250	272	60.2	152.0	213	6.5	77
CX1280	312	65.2	182.0	213	6.5	77
CX2415	243	54.2	135.0	183	6.5	72
CX2425	272	60.2	152.0	213	6.5	77
CX2440	312	65.2	182.0	213	6.5	77

2-3-1. CX1215 / 1225 / 1235 / 2415 (Front Panel)

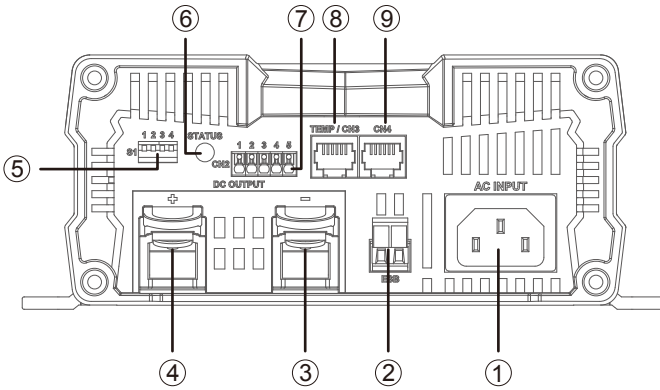

Figure 5. CX1215 front panel

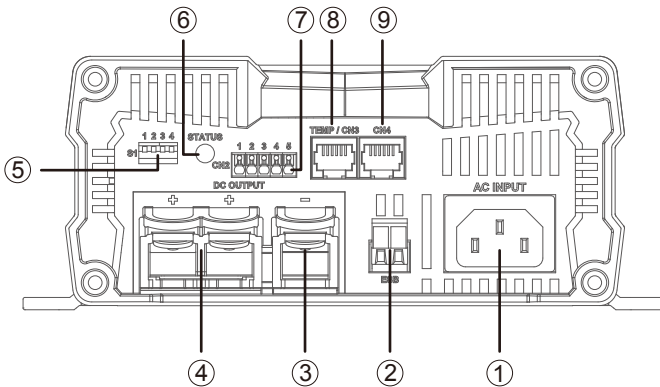

Figure 6. CX1225/1235/2415 front panel

Front panel			
①	AC Inlet (IEC)	⑥	Status LED
②	ESB connector (only CX 1215/1225/1235)	⑦	CN2
③	DC output -	⑧	TEMP/CN3
④	DC output +	⑨	CN4
⑤	Dip Switch 1 (S1)		



Note: For detail description on item 5 (Dip Switch S1), please refer to section 3-2

2-3-2. CX1215 / 1225 / 1235 / 2415 (Rear Panel)

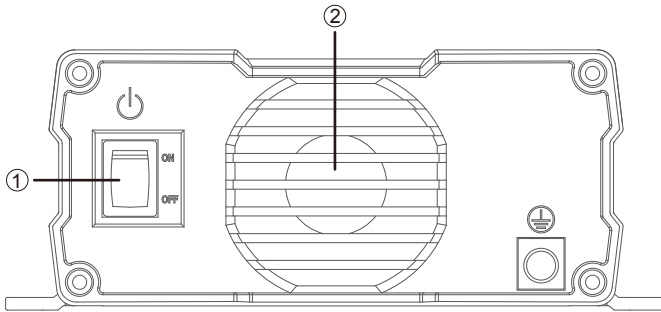

Figure 7. CX1215/1225/1235/2415 rear panel

Front panel			
①	AC Inlet (IEC)	②	Status LED

2-3-3. CX1250 / 1280 / 2425 / 2440 (Front Panel)

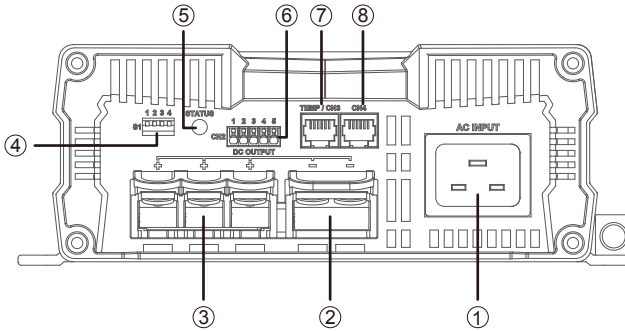

Figure 8. CX1250/1280/2425/2440 front panel

Front panel			
①	AC Inlet (IEC)	⑤	Status LED
②	DC output -	⑥	CN2
③	DC output +	⑦	TEMP/CN3
④	Dip Switch 1 (S1)	⑧	CN4



Note: For detail description on item 4 (Dip Switch S1), please refer to section 3-2

2-3-4. CX1250 / 1280 / 2425 / 2440 (Rear Panel)

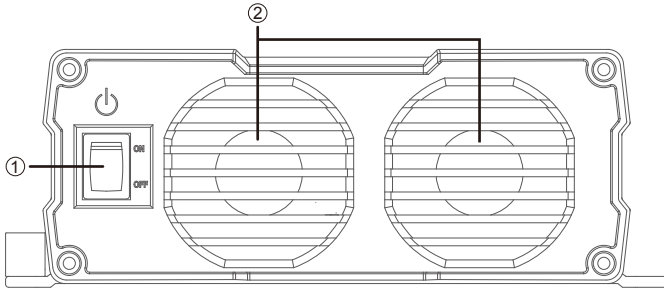

Figure 9. CX1250/1280/2425/2440 rear panel

Front panel	
①	Power Switch
②	Fan





3. Product Description

Below models are available with COTEK Advanced Battery Charger CX Series:

Model	No. of supply battery	Support ESB (Extra Second Battery)
CX1215	1	Yes
CX1225 / CX1235	2	Yes
CX1250 / CX1280	3	No
CX2415	2	No
CX2425 / CX2440	3	No



3-1. Configurations

3-1-1. Standard Accessory

Number	A	B	C	D
Description	Copper Bus		Screw	AC Power Cable
Diagram				

Quantity per	CX 1215	CX 1225	CX 1235	CX 1250	CX 1280	CX 2415	CX 2425	CX 2440
A	x	1pcs	1pcs	x	x	1pcs	x	x
B	x	x	x	1pcs	1pcs	x	1pcs	1pcs
C	x	2pcs	2pcs	3pcs	3pcs	2pcs	3pcs	3pcs
D	1pcs	1pcs	1pcs	1pcs	1pcs	1pcs	1pcs	1pcs

3-1-2. Optional Accessory

Number	A	B	C
Description	Ring Terminal	Battery Temp Sensor	Remote
Diagram			

Number	CX 1215	CX 1225	CX 1235	CX 1250	CX 1280	CX 2415	CX 2425	CX 2440
A	2pcs	3pcs	3pcs	5pcs	5pcs	3pcs	5pcs	5pcs
B	1pcs	1pcs	1pcs	1pcs	1pcs	1pcs	1pcs	1pcs
C	1pcs	1pcs	1pcs	1pcs	1pcs	1pcs	1pcs	1pcs

3-2. S1 Setting

3-2-1. Dip switch setting

Status	1	2	3	4	12V / 24V CC/CV	12V / 24V Float
CC turn to CV voltage	ON	X	OFF	X	14.4V / 28.8V	---
	OFF	X	OFF	X	14.7V / 29.4V	---
Float voltage	X	ON	OFF	X	---	13.5V / 27.0V
	X	OFF	OFF	X	---	13.8V / 27.6V
Power Mode (Current limit output voltage)	OFF	OFF	ON	X	13.2V / 26.4V	
	OFF	ON	ON	X	13.8V / 27.6V	
	ON	OFF	ON	X	14.4V / 28.8V	
Remote	ON	ON	ON	X	---	---
Sleep Mode	X	X	X	ON	---	---
	X	X	X	OFF	---	---

X: Not Applicable

---: By Default setting

3-2-2. Default setting

Model	12V Series	24V Series
CC/CV	14.4V	28.8V
Float	13.8V	27.6V
Power Mode	Off	Off
Remote	Off	Off
Fan	Full Speed	Full Speed

3-3. Charging Status LED Indicator

Charging status	LED Status	
Bulk-1	Orange fast	-----
Bulk-2	Orange slow	- - - - -
Absorption-1	Orange solid	=====
Absorption-2	Green solid	=====
Float	Green flash
	LED color change by the status change	

3-4. Failure Indicator

Failure status	LED Status		Description
Input or Output	Red solid	=====	Output current is reduced to <1A
			AC I/P unstable
			Output FUSE blown
Temperature	Red fast	-----	Battery over heat (the indicator is available only when COTEK temperature sensor is connected)
			Battery under heat (the indicator is available only when COTEK temperature sensor is connected)
			Charger over heat (Heat Sink)
Battery voltage	Red slow	- - - - -	Battery over voltage
			Battery under voltage or output under voltage in C.C. mode.
Fan abnormality	Red light flash twice	- - - - -	Fan abnormality
ESB Failure	Red slow every 2 sec.	- - - - -	ESB no output / output short

3-5. Pin Assignment of CN2 – For Alarms Signal & Fan Control

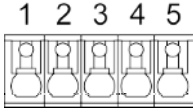
1	Normally closed	
2	Normally open	
3	COM	
4	Sleep mode control	
5	GND	

4-5 Short	Sleep mode on
4-5 Open	Sleep mode off

3-6. Sleep Mode

#	CR-1	CN2 ^{*1}	Sleep Mode	Fan Speed
A	OFF	OFF	OFF	Fan will operate according to heat sink temperature and loads condition
B	OFF	ON	ON	Fan operates at 50% duty
C	ON	ON	ON (deep sleep)	Fan stop
D	ON	OFF	ON (deep sleep)	Fan stop

After 8 hours to use CR-1^{*2} to start Sleep Mode, then the sleep mode will stop. Please use the CN2 to determine the Sleep Mode ON/OFF.

*1 : Please refer to 3-5.

*2 : CR-1 is the CX remote controller, and sleep mode can be set by this remote controller.

3-7. Pin Assignment of CN3 – For Temperature sensor & Remote control

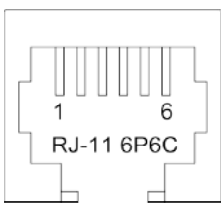
1	R_VCC	
2	GND	
3	TEMP	
4	BAT-	
5	DATA I/O	
6	NC.	

3-8. Pin Assignment of CN4 – For Remote control

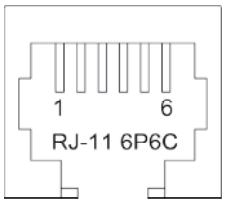
1	R_VCC	
2	BAT-	
3	NC.	
4	BAT-	
5	DATA I/O	
6	NC.	

3-9. Pin Assignment of ESB Connectors – For CX1215/1225/1235

+	VCC	
-	GND	

3-10. Temperature Compensation

- CX12XX series model

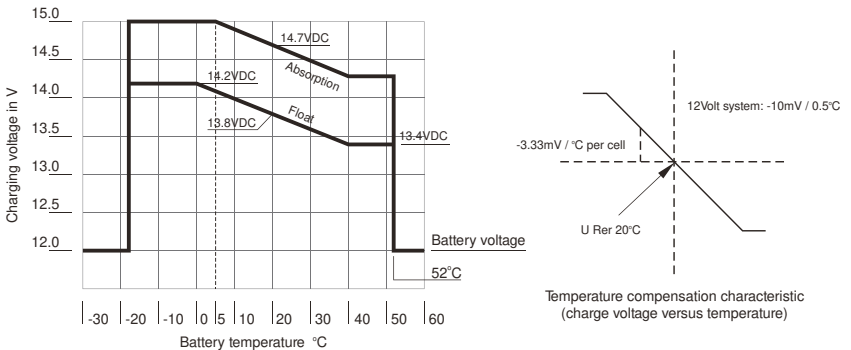

※ In the CV=14.7V and float=13.8V situation.
Please follow this rule in other situations.

Figure 10. CX12xx model Temperature Compensation

- CX24XX series model

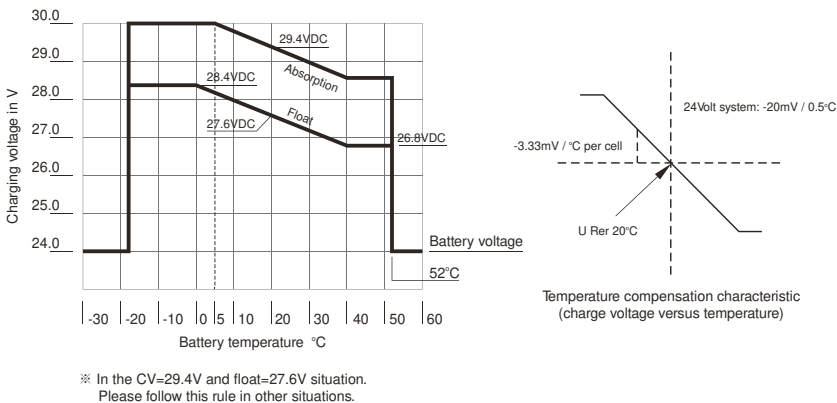

Figure 11. CX24xx model Temperature Compensation

3-11. Rescue Battery Curve

In case of battery over discharge (when battery voltage lower than 10V), CX battery charger will reduce the charging current to prevent further damage on the battery.

The following curve is only applicable for Lead-acid & AGM battery.

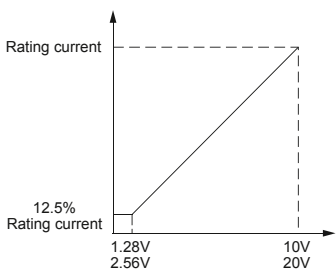

Figure 12. Lead-acid & AGM battery curve

3-12. Battery Charger Selection (Reference only)

- 12 Volt Battery

COTEK Model	Battery capacity range	Estimated charging time
CX1215	50~80Ah	6~24
CX1225	80~125Ah	6~24
CX1235	125~175Ah	6~24
CX1250	175~250Ah	6~24
CX1280	250~400Ah	6~24

The above suggested battery charger selection is based on battery capacity multiply 0.2~0.3. Example: 100Ah battery
 * $0.2 / 0.3 = 20A \sim 30A$ in this case please select CX1225.

- 24 Volt Battery

COTEK Model	Battery capacity range	Estimated charging time
CX2415	50~80Ah	6~24
CX2425	80~125Ah	6~24
CX2440	125~200Ah	6~24

The above suggested battery charger selection is based on battery capacity multiply 0.2~0.3. Example: 100Ah battery
 * $0.2 / 0.3 = 20A \sim 30A$ in this case please select CX2425.

3-13. Battery Voltage setting suggestion

- GEL TYPE (Max. Voltage of 14.1 / 28.2 Volt)
- AGM TYPE (Max. Voltage of 14.4 / 28.8 Volt)
- Lead-Acid (Max. Voltage of 14.8 / 29.6 Volt)

3-14. Fan speed duty description

The fan determined by load and heat sink temperature.

1. Fan speed 100%: comply with one of the following conditions
 - a. Load $\geq 75\%$
 - b. Load $\geq 50\%$ and heat sink temperature $\geq 50^{\circ}\text{C}$
 - c. Heat sink temperature $\geq 75^{\circ}\text{C}$
2. Fan speed duty 50%:
 - a. Heat sink temperature $\geq 67.5^{\circ}\text{C}$
or
 - b. Set CX to sleep mode by setting DIP4 (Refer to 3-2) when
 1. a, b, or c applies
3. Fan speed duty 0%:
 - a. Load $< 75\%$ and heat sink temperature $< 35^{\circ}\text{C}$
or
 - b. Sleep mode turned on by CR-1

4. Installing Converter / Charger

When selecting the installation location, observe the following instructions:

- The battery charger can be installed horizontally or vertically.
- Do not install the charger in following situations:
 - ✧ In wet environments
 - ✧ In dusty environments
 - ✧ In the vicinity of combustible materials
 - ✧ In areas where there is a danger of explosions
- The place of installation must be well ventilated. A ventilation system must be available for installations in small, enclosed space. The clearance around the device must be at least 25cm.
- The air inlet on the underside and the air outlet on the back of the device must remain clear.
- For ambient temperatures higher than 40 °C (such as in engine or heating compartments, or direct sunlight), the heat from the charger under load can lead to reduced output.
- The charger must be installed on a level and sufficiently sturdy surface.
- Do not install the charger in the same area as the batteries.
- Do not install the charger above batteries, because they can emit corrosive sulphur fumes that will damage the device.



Notice!

Before drilling any holes, make sure that no electrical cables or other parts of the vehicle can be damaged by drilling, sawing and filing.

For installation and mounting you will need the following tools:

- Pen for marking
- Drill bit set
- Drill
- Screwdriver

To secure the charger in place you will need:

- Machine bolts (M4) with washers and self-locking nuts or
- Self-tapping screws or wood screws

Fasten the charger as follow:

- Hold the charger against the installation location
- Mark the fastening points
- Fasten the charger with one screw through each hole in the holders

4-1. Battery charger connection diagram

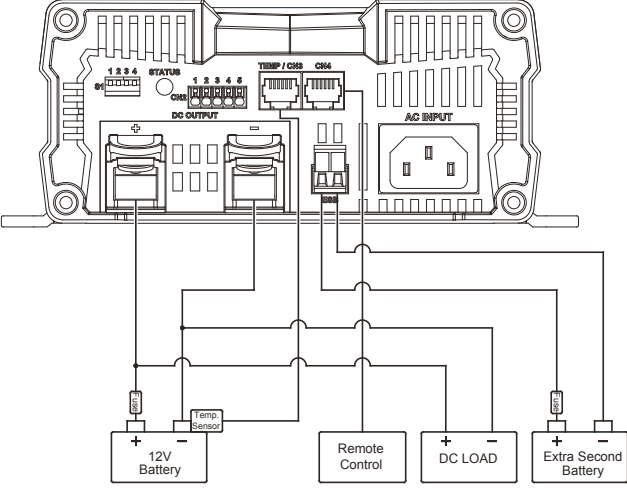
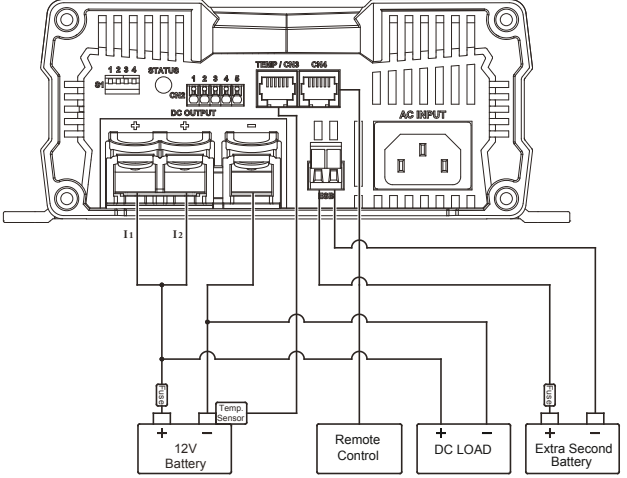
Model	Description	Connection diagram
<p>CX1215</p>	<p>15A MAX</p>	 <p>Fuse Voltage : 32V, Fuse Current : 23A</p>
<p>CX1225 CX1235</p>	<p>• I1+I2 CX1225 : 25A MAX CX1235 : 35A MAX</p>	 <p>CX1225 Fuse Voltage : 32V, Fuse Current : 40A CX1235 Fuse Voltage : 32V, Fuse Current : 50A</p>

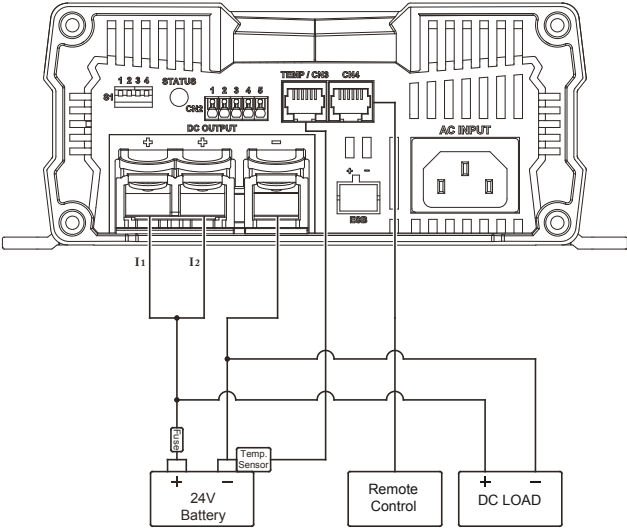
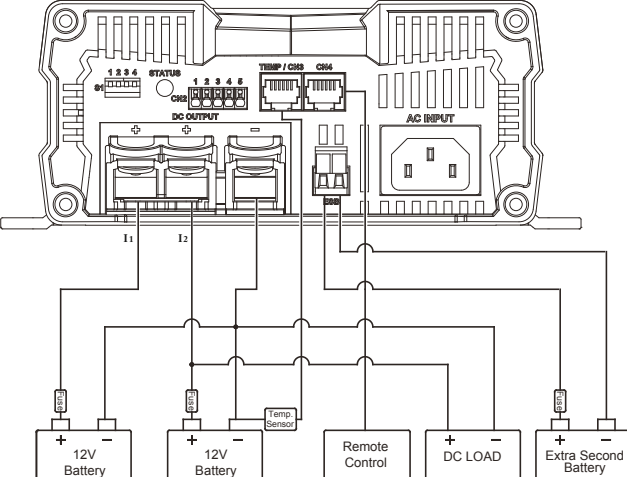
Model	Description	Connection diagram
<p>CX2415</p>	<ul style="list-style-type: none"> • I1+I2 12.5A MAX 	 <p>Fuse Voltage : 32V, Fuse Current : 23A</p>
<p>CX1225 CX1235</p>	<ul style="list-style-type: none"> • I1 or I2 CX1225 : 25A MAX CX1235 : 35A MAX 	 <p>CX1225 Fuse Voltage : 32V, Fuse Current : 40A CX1235 Fuse Voltage : 32V, Fuse Current : 50A</p>

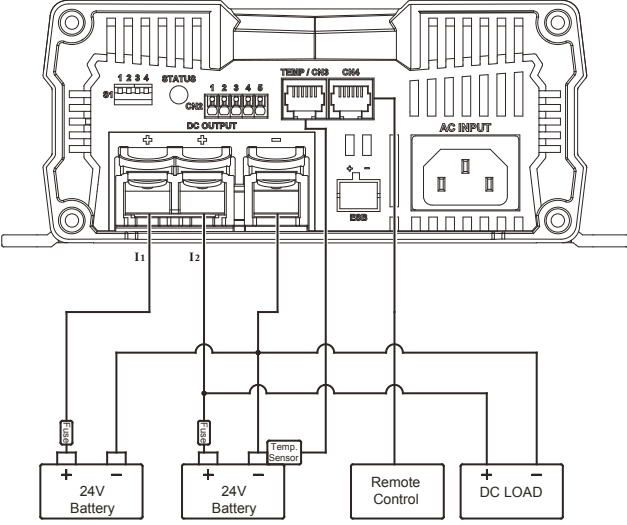
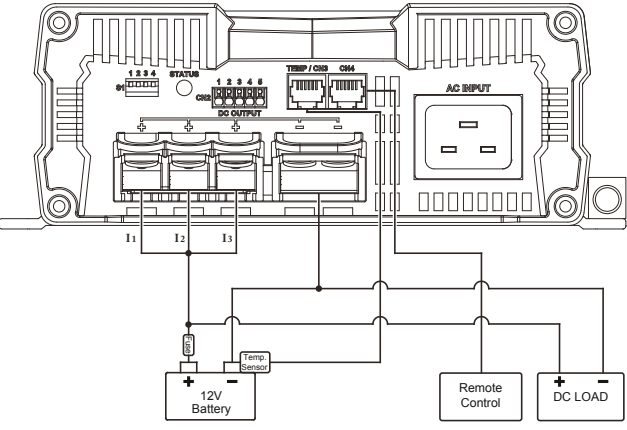
Model	Description	Connection diagram
<p>CX2415</p>	<p>• I1 or I2 12.5A MAX</p>	 <p>Fuse Voltage : 32V, Fuse Current : 23A</p>
<p>CX1250 CX1280</p>	<p>• I1+I2+I3 CX1250 : 50A MAX CX1280 : 80A MAX</p>	 <p>CX1250 Fuse Voltage : 32V, Fuse Current : 80A CX1280 Fuse Voltage : 32V, Fuse Current : 125A</p>

Model	Description	Connection diagram
CX2425 CX2440	• I1+I2+I3 CX2425 : 25A MAX CX2440 : 40A MAX	<p> CX2425 Fuse Voltage : 32V, Fuse Current : 40A CX2440 Fuse Voltage : 32V, Fuse Current : 80A </p>

5. Trouble Shooting

LED display	Cause	Remedy
Red, slowly flashing	Battery under voltage or battery overload	Check the battery. Switch the battery charger off and on again.
	Defective battery	Replace the battery
Red, rapidly flashing	Overheating	Improve the ventilation of the battery charger or battery. Make sure that no ventilation openings are covered. If necessary, reduce the ambient temperature.
Red, permanently lit	Short circuit or reversed polarity	Connect the battery charger with the correct polarity. Rectify the short circuit. Check if the fuse has blown and replace it if necessary.
Red, double flash	Fan fault	Check the fan for dirt or damage.
Red, slow, every 2 sec.	Fault at the starter battery connection	Check the starter battery connection for a short circuit.

6. Warranty Statement

6-1. Warning



Warning!

Do not open or disassemble the Converter / Charger. Attempting to do so may cause risk of electrical shock or fire.

6-2. Warranty

We guarantee this product against defects in materials and workmanship for a period of 24 months from the date of purchase. In case you need to repair or replace any defective power inverters, please contact COTEK local distributor.

This warranty will be considered void if the unit has been misused, altered, or accidentally damaged. COTEK is not liable for anything that occurs as a result of the user's fault.

COTEK

No.33, Sec. 2, Renhe Rd., Daxi Dist., Taoyuan City 33548, Taiwan

Phone : +886-3-3891999 FAX : +886-3-3802333

[http : // www.cotek.com.tw](http://www.cotek.com.tw)

2016.07._A0